

Component Catalogue 2017



- MICRO SWITCHES
- CONNECTORS
- CONTACTOR RANGE
- MANUFACTURING CAPABILITIES



Introduction

Your Material Component Partner – Our experience is your guarantee.

Our experience is your guarantee

For more than 45 years, Schaltbau Machine Electrics Ltd. has been delivering high quality products and effective services to the Materials Handling industry.

We have built our reputation on working closely with both OEM's and service companies by providing new and replacement electrical parts and accessories for fork lift trucks.

Strength to deliver quality at competitive prices

With Machine Electrics Ltd. now a subsidiary of Schaltbau GmbH, a specialist in Transportation and Industrial sectors, Schaltbau Machine Electrics gains further breadth of experience and strength to continue to deliver high quality products at competitive prices.

Leading the way with a flexible service and reliable delivery

Our in-depth experience of delivering new and replacement parts to fork lift truck service companies enables us to help you identify quickly and accurately a broad variety of the parts you need to ensure the continuous and economic running of your plant and equipment.

This catalogue details the variety of electromechanical components available from Schaltbau Machine Electrics.

This is only a small selection of the most popular components we can supply. If a particular part you require is not shown or listed please contact us.

Electrical components for industrial trucks

Thanks to its extensive product range, Schaltbau Machine Electrics has the right component for every type of battery-powered industrial truck.

Contactors

A vast range of product lines enables Schaltbau Machine Electrics to supply replacement and new contactors for most leading brands of trucks.

Replacement contacts and kits

Need replacements parts for contactors? Schaltbau Machine Electrics supply equivalent parts for most manufacturers, Schaltbau, Cableform, Ametek, GE and many other popular makes.

Connectors, Cables and Components

Schaltbau Machine Electrics stocks a wide variety of connectors, cable assemblies and components. From charging connectors to emergency switches, micro-switches and snap action switches, our goal is to supply all your needs with fast and flexible delivery.

Contents

Description	Page
Schaltbau Connectors	1-3
Anderson Connectors	4-5
Miscellaneous Connectors, Ravioli & Pendants	6
Cables and Harnesses, Cow bells	7-8
Cable Retractors and accessories	9
Contactors AFS & C310	10-11
HB Contactors	12
Cableform Contactors and Solenoids	13
Cam Contactors	14
Emergency Stop Switches	15
AFS Contact Kits	16-20
Brackets & Links	21
Cableform Contactor Spares	22-23
GE EV1, EV100 Contacts	24-25
Contacts for Crown, Still, Linde.	26
Japanese Contacts - Komatsu, TCM, Nissan, NYK, Toyota, Keiki.	27-28
HB Contacts Kits	29-30
Schaltbau Contact Kits and Components	31
Contact Kits and Components / Misc.	32
Micro-switches, Push and Rocker Switches	33
Snap Action Switches	34
Key, Lever Switches	35
Brushes and Accessories, Com Sticks	36
Fuses & Fuse holders	37
BDI & hour meters, Beacons and Buzzers, Wheel Spinners.	38

Schaltbau Connectors – DIN 80, 160, 320, 400A & HPC

LV connectors Current ranges

80 A, 160 A, 320 A, 400 Amp



- | | | |
|----|--------------------------------|------------|
| 1. | 25mm 150A FEMALE | SLV080F/01 |
| 2. | 25mm 150A MALE | SLV080M/01 |
| 3. | 160/320 HANDLE BLACK +4 SCREWS | SLV057 |
| 4. | 50mm 250A MALE | SLV160M/01 |
| 5. | 50mm 250A FEMALE | SLV160F/01 |
| 6. | 70mm 400A FEMALE | SLV320F/01 |
| 7. | 70mm 400A MALE | SLV320M/01 |

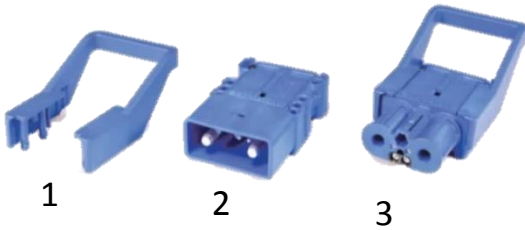

1. 500 HANDLE BLUE SNAP ON
2. 4/0 AWG 500A MALE+ PILOTS+A
3. 4/0 AWG 500A FEMALE+ PILOTS+AUX+HANDLE

SLV070
SLV500M/02
SLV500F/02



**LV-HPC Series High Power Connectors
for industrial trucks – Call us for
Details**

LV plugs are configured using this format - LV1-2-3-4-5-6-7

Pos. in description	Symbols	Explanation
1	LV80, LV160, LV320	Series LV80, LV160, LV320
2	T, N, U	Voltage keys: Tgn, Ngr, Uge - (green, grey, yellow)
3	P25, S25	Main contacts (P=pin, S=socket) + (Cable Size in mm)
4	0, 2	Pilot contact (0=without, 2=with 2 PC)
5	0, 2	Auxiliary contact (0=without, 2=with 2 AC)
6	L0, L1	Air supply adapter (0=without, 1=with)
7	H0, H1, H2	Handle (H0=without, H1=black handle, H2=red handle)

Example - LV320-T-S95-0-0-L0-H1

- 320 Amp Shell
- Green Key for Dry-cell Battery
- Socket for 95mm Cable
- Without Pilot Contact
- Without Auxiliary Contact
- Without Air Supply
- With Black Handle

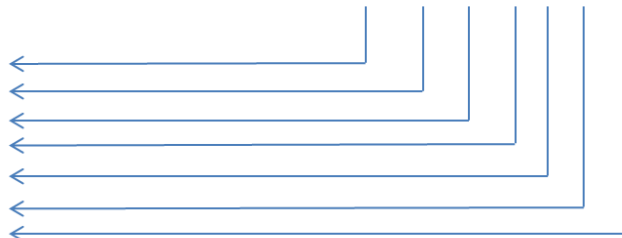

(Other Cable sizes available)

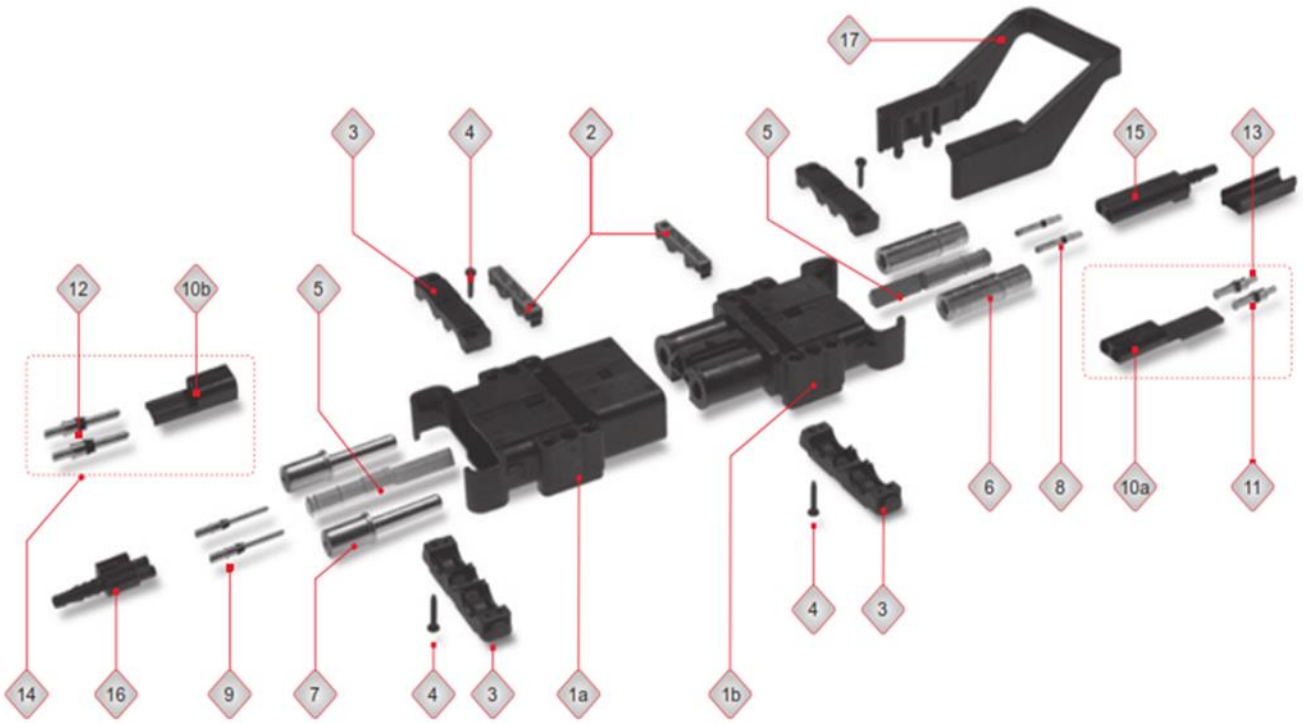

1a	Plug Shell	11	Pilot contact (socket)
1b	Receptacle Shell	12	Pilot contact (pin)
2	Slider	13	Pilot contact set (socket)
3	Clamp	14	pilot contact set (pin)
4	Screw for clamp	15a	Air tube adaptor (receptacle)
5	Keying Plug	15b	Spacer (receptacle)
6	Main Socket	16	Air tube adaptor (plug)
7	Main Contact	17	Handle LV (snap on)
-	Reducing Bush --	--	Handle LV (screw on)
8	Aux Contact (socket)	--	Extra tube adaptor
9	Aux Contact (pin)	--	
10a	Pilot contact adaptor (socket)		
10b	Pilot contact adaptor (pin)		

Please call us for price and availability on all component parts

Schaltbau Connectors – DIN 80, 160, 320, 400 Amp and HPC

Accessories

AWZ-C/H Extraction tool for pilot and auxiliary contacts

Series	Type of contact	Extraction tool
LV80	Pilot contacts LV80 BBC-2.5-Ag LV80 SBC-2.5-Ag	LV80 AWZ-B
	Aux. contacts LV80 BBC-2.5-Ag LV80 SBC-2.5-Ag	
LV160	Pilot contacts BCC-2.5-Ag SCC-2.5-Ag	AWZ-C/H
	Aux. contacts LV160 BBC-2.5-Ag LV160 SBC-2.5-Ag	LV160 AWZ-B
LV320	Pilot contacts BCC-2.5-Ag SCC-2.5-Ag	AWZ-C/H
	Aux. contacts LV320 BCC-2.5-Ag LV320 SCC-2.5-Ag	... *)

*) LV320 Series auxiliary contacts are secured from falling out of the shell by means of the slider.



Extraction tool AWZ-C/H
for pilot contacts LV160, LV320



Extraction tool LV160 AWZ-B
for auxiliary contacts



Extraction tool LV80 AWZ-B
for pilot and auxiliary contacts



Crimp tool Stocko WHPH10
for the main contacts



CWZ-600-1 14-6.00



Cable Reducers

Pilot Contacts

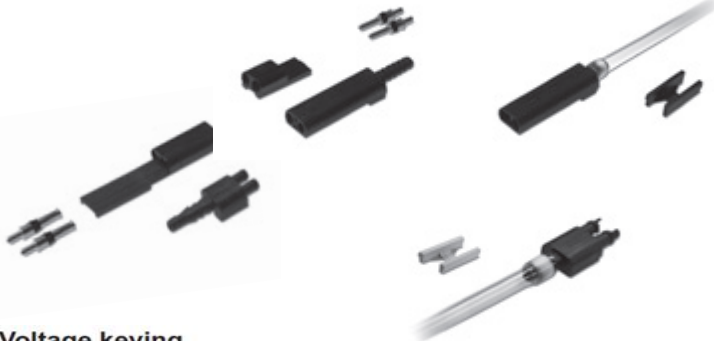

Air/ Water Tube Adaptor







General Rule

Water top up, colour: GREY
Connecting tube for multifunctional adapter

Electrolyte circulation, colour: BLUE
Connecting tube for multifunctional adapter or
air tube adapter

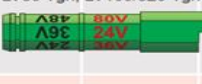
Contents in tubes, pipes and containers shall be
marked in colour with flow direction, danger
symbol for labelling hazardous substances, and
text.

Voltage keying

LV80, LV160 or LV320 Series			Voltage keying	Implemented in		Application keying Keying plug for
Pin	Socket	Application keying		Receptacle shell	Plug shell	
LV80 Ngr, LV160/320 Ngr		N		•	•	Plug shell Charging station wet-cell battery «N» Battery receptacle Wet-cell battery «N»
LV80 Tgn, LV160/320 Tgn		T		•	•	Plug shell Charging station dry-cell battery «T» Battery receptacle Dry-cell battery «T»
LV80 Uge, LV160/320 Uge		U		---	•	Plug shell Vehicle plug (universal) «U» Battery receptacle ---

Anderson Connectors 80A, 160A, 350A

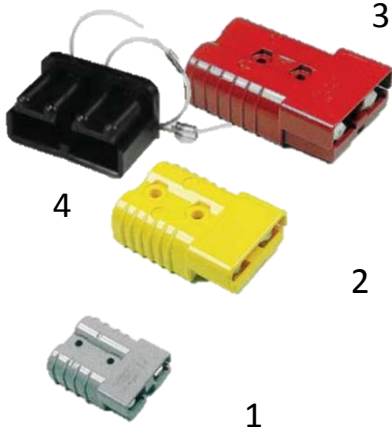

- | | |
|------------------------|-----------|
| 1. SB50 Grey 10/12awg | 6319G1 |
| 2. SB175 Yellow 1/0awg | 6328G1 |
| 3. SB350 Red 2/0awg | 6322G1 |
| 4. SB175 Dust Cover | 1342G2-B1 |

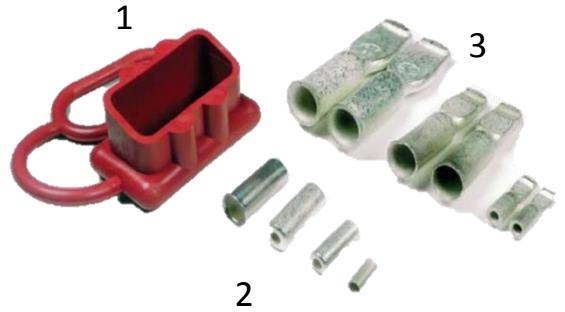

- | | |
|---------------------------|--------------------------|
| 1. SB175 Dust Cover – Red | 134G2 |
| 2. Reducers | Call us for more details |
| 3. Contact Set | Call us for more details |

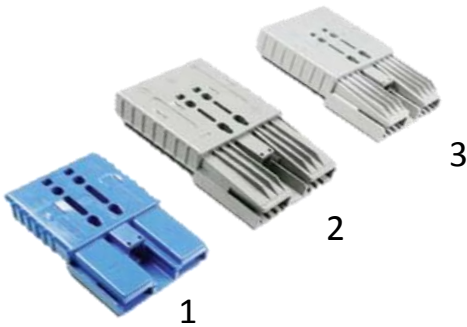

2 pole + Aux

- | | |
|-----------------------|---------|
| 1. SBE160 Blue 1/0awg | E6375G1 |
| 2. SBE320 Grey 2/0awg | E6345G1 |
| 3. SBX350 2/0awg | 6345G1 |

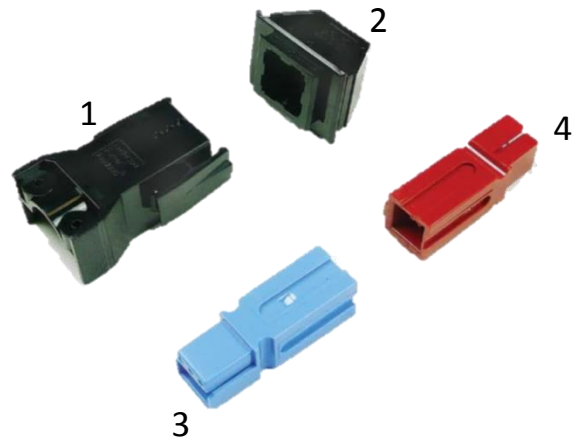

Power Pole

- | | |
|--------------------------------------|----------|
| 1. PP PAK Housing + Latch 2/3/4 pole | PP1460G1 |
| 2. PP PAK REC 2/3/4 Pole | PP1470G1 |
| 3. 75A P/Pole Housing Blue | PP75/07 |
| 4. 75A P/Pole Housing Red | PP75/09 |

Anderson Accessories 80A, 160A, 350A

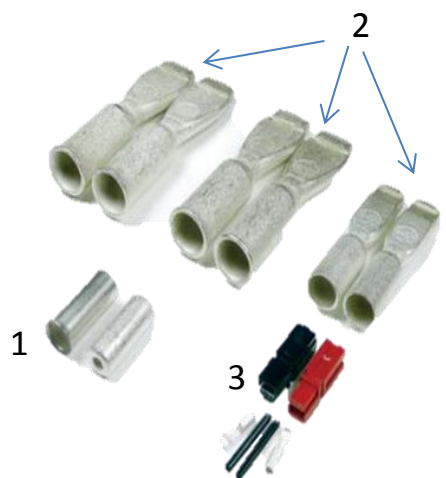

SBE Contacts

1. Reducer (various sizes)
2. Contact Set (various sizes)
3. Aux Contact Kit

Call us for more details
Call us for more details
6344

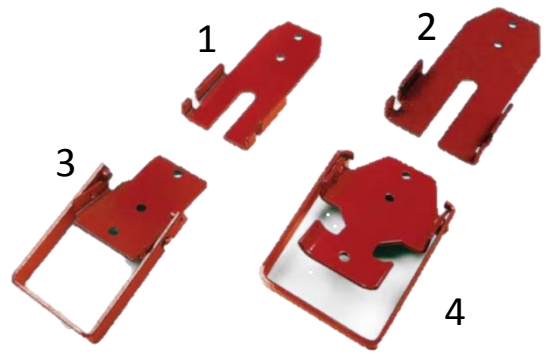

2 pole Handles

1. Man Release SB175
2. Man Release – charger SB350
3. Man Release – battery SB175
4. Man release clamp – battery SB350

	924
	922G1
	923
	919



1. Handle Red
2. SBX350 Truck charger Handle
3. Battery Plate SBX350/SBE320
4. SBE 50 Handle
5. SBX175 Handle

	995G34
	994G1
	993G1
	SB50-HDL
	995G1

Miscellaneous Connectors

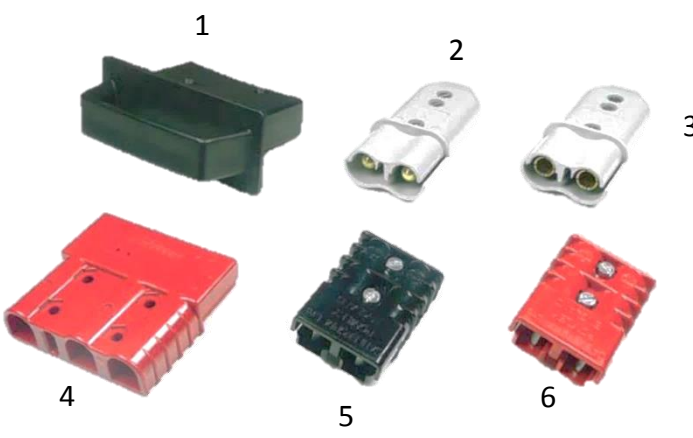

1. Green handle for SAE3160
2. White BT Male Connector
3. White BT Female Connector
4. Red SAE3160 3 Pole Connector
5. Green Cableform Connector
6. Red Cableform Connector

Misc. Connectors

1. Handle for SAE3160	S3524/01
2. BT Male Connector	S3517
3. BT Female Connector	S3516
4. SAE3160 3 Pole Red 35mm	69351
5. Cableform Connector Black	CC21-1-1
6. Cableform Connector Red	CC21-1-2

Ravioli Connectors and Pendant Stations

Pendant Stations – Call for options





N. Buttons	Dimensions (mm)				Weight (Kg.)
	A	B	C	D	
2	264	166	66	77	0,280
4	336	238	66	77	0,430
6	424	310	71	82	0,590
8	496	382	71	82	0,750
10	568	454	71	82	0,880
12	640	526	71	82	1,040



- Special execution for Cleaning Machines
- Glow wire tested (850 ° C)
- Protection degree IP 23

Rating current 80 – 160 – 320 A
Rating voltage 150 V dc Operating
Temperature – 20 ° C ÷ + 90 ° C

CALL US FOR RAVIOLI DIN
PLUG OPTIONS

Cables and Cable Harnesses

1. Custom Harnesses
2. 35TF 02.00 SB175GY C/HF
3. 25TN 00.75 SBERD TH+/-

Call us
L3015/35
L3010/9

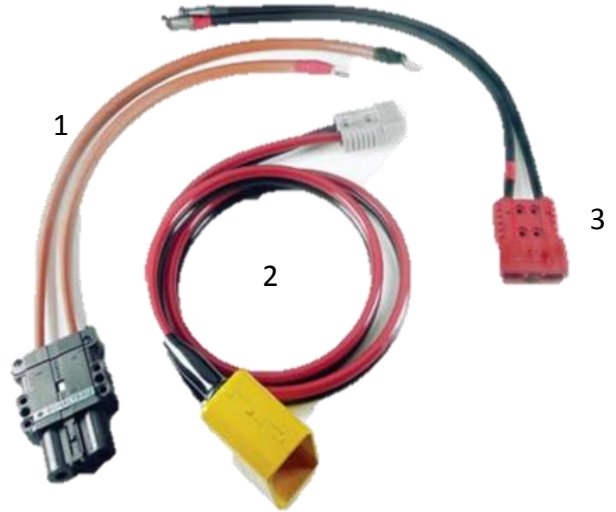

Bespoke Harnesses made to order

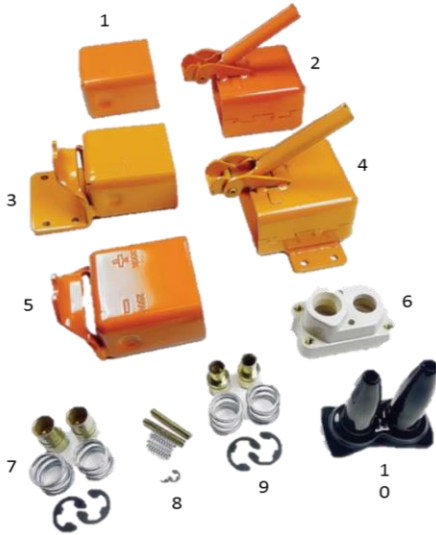

EC Cow Bell Connectors

- | | |
|-------------------------------------|-----------|
| 1. Charging Half Case | 5841 |
| 2. Locking Half Case | 5840 |
| 3. Mounting Half Case | 5842 |
| 4. CABAC Locking Half Case (4 hole) | H3619/A |
| 5. Yale Mounting Case no Bracket | H3627/A |
| 6. E Conn Moulding Shatterproof | 66-0171/S |
| 7. E Conn Main Contact Kit 2/0 | 66-0181 |
| 8. E Conn Aux Contact Kit | 65-0146 |
| 9. E Conn Main Contact Kit #2 | 66-0181C |
| 10. Cable Gland EC | 65-0147 |

Contact us for Bespoke wiring harnesses

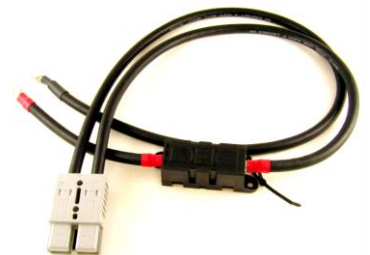

In-line fuse option



- | | |
|------------|-------------------|
| 1. S2101/1 | TERMINAL (M8X20) |
| 2. S2101/2 | TERMINAL (M10X20) |
| 3. S2101/3 | TERMINAL (M12X45) |

Cables and Cable Accessories



1	CABLE 50mm PLAIN	H3641/50	12	SOLDER 60/40 TINMANS 250gr	X1002
2	CABLE 35mm PLAIN	H3641/35	13	TWINFLEX RED/BLACK 25mm	H3644/25
3	CABLE 25mm PLAIN	H3641/25	14	TWINFLEX RED/BLACK 35mm	H3644/35
4	CABLE 16mm PLAIN	H3641/16	15	TWINFLEX RED/BLACK 50mm	H3644/50
5	CABLE 50mm TINNED	H3642/50	16	THIMBLE +VE HEX 70mm	H3646
6	CABLE 35mm TINNED	H3642/35	17	THIMBLE -VE HEX 70mm	H3647
7	CABLE 25mm TINNED	H3642/25	18	BATT TAKE OFF +VE	H3646/1
8	CABLE 16mm TINNED	H3642/16	19	BATT TAKE OFF -VE	H3647/1
9	CROCODILE CLIP +VE 100a	H3685/1	20	Crimp Terminal & splice Terminals	Q5801
10	CROCODILE CLIP -VE 100a	H3685/2	21	H SHRINK RED D19mm x L25mm	X1007/25
11	KT25 CRIMPING TOOL (10-95mm)	Z1037	22	H SHRINK BLUE D19mm x L25mm	X1008/25
			23	H SHRINK BLACK D19mm x L25mm	X1006/25

We are able to provide Bespoke cable harnesses – please call for price and availability

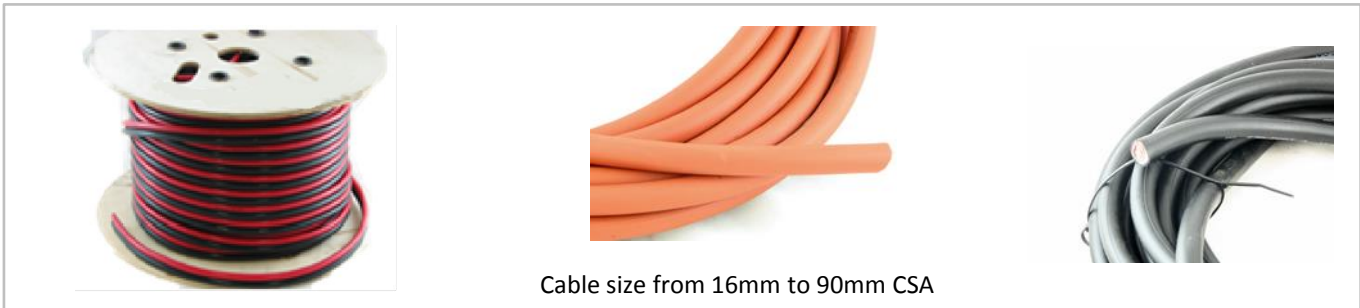

We have a wide selection of Cables and sizes, please call for prices.

Cable Saver / Retractors

- 1 CABLE RETRACTOR 1.8kgs PBF Y5609/A
- 2 CABLE SUPPORT Y5608/E



Y5611/03 1-3603-334750



Y5611/02 1-3603-334749



Cable Retractor / Saver

- HEAVY-DUTY, LONG-LIFE SPRING FOR LASTING PERFORMANCE
- EASY TENSION ADJUSTMENT WITH NO TOOLS REQUIRED
- FULL RANGE OF MOTION WITH 360° SWIVEL HANGER
- QUICK INSTALLATION
- DURABLE NYLON OR WIRE CORD FOR LONG LIFE AND REDUCED MAINTENANCE
- CONVENIENT SNAP-TYPE TOOL CLIP FOR EASY TOOL HANDLING
- ALIGNMENT OF HANGER AND TOOL HOOK FOR SMOOTH, EFFICIENT USE

Hose / Cable Support

- INCREASES WORKER SAFETY BY KEEPING HOSES/CABLES OUT OF THE WAY
- INCREASES HOSE/CABLE LIFE AND EFFICIENCY
- ALLOWS EASY ACCESS TO HOSE/CABLE WHEN NEEDED
- WORKS WELL WITH OUR BALANCERS AND TORQUE REELS FEATURING RATCHET LOCK

To minimise risks Health and Safety Executive:

Avoid applying too much force for too long or too frequently using an awkward Posture of the hand, wrist or arm.

Consider reducing the force involved by, for example:

Keeping cutting tools sharp Providing a larger gripping area supporting tools by means of balancers or tensioners.

Most ill health arises from:

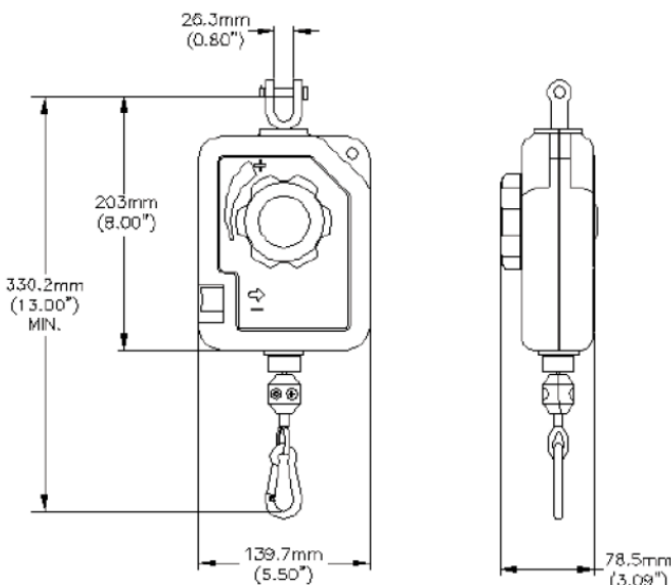

Prolonged forceful or repetitive gripping, twisting, reaching or other movement without enough rest or recovery. This causes pain, a restriction of joint movement and soft tissues swelling, leading sometimes to permanent disability, mostly in the hands, arms and shoulders Lifting and handling goods unsafely by hand.

Key reference: Upper limb disorders in the workplace HSG60 HSE Books ISBN0717619788



2.7 Kg Model Shown

AFS Contactors

- | | | | | |
|--|--|--|---|---|
| <p>1</p>  | <p>2</p>  | <p>3</p>  | <p>4. 150A SPST Contactor
5. 150A DPDT Contactor
6. 80A SPST Contactor
7. 150A DPDT Contactor
8. 80A SPST Contactor</p> | <p>AFS711
AFS798
AFS11
AFS819
AFS817
AFS14
AFS717
C100/80</p> |
|--|--|--|---|---|

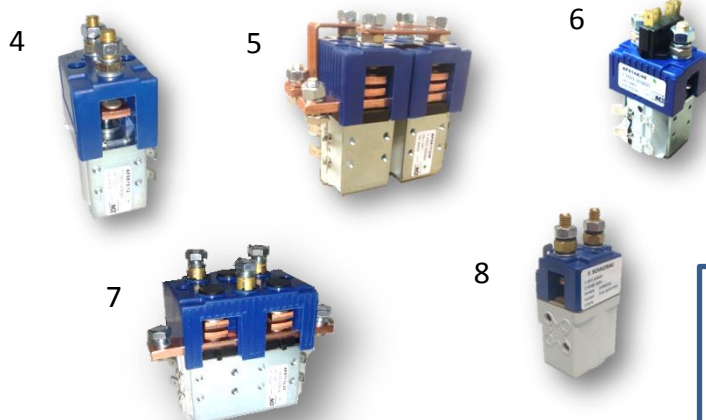

This is just a small sample range. For more options, please call us.

C310



Series	C310/150		C310/300	
Type of voltage	DC (bidirektional)		DC (bidirektional)	
Main contacts (number, configuration)	1x SPST-NO		1x SPST-NO	
Nominal voltage U_n	48 V	750 V	48 V	750 V
Rated insulation voltage U_i	1000 V		1000 V	
Rated impulse withstand voltage U_{imp}	8kV		8kV	
Conventional free air thermal current I_{th} @85°C	150 A		300 A	
Rated short-time withstand current I_{cw}	2000A, 1s		2000A, 1s	
Rated short-circuit breaking capacity I_{cn}	200A @60V L/R=0,1ms	200A @750V L/R=0,1ms	350A @60V L/R=0,1ms	350A @750V L/R=0,1ms
Coil control supply voltage U_s	9-36V 32 – 60V (-40 - +85°C)		9-36V 32 – 60V (-40 - +85°C)	
Mechanical endurance	> 1,000,000) operating cycles for standard coils		> 1,000,000 operating cycles for standard coils	
	> 10,000 operating cycles for bi-stable coils		> 10,000 operating cycles for bi-stable coils	
Mounting position	Horizontal or vertical (Base (coil) studs must point downwards)		Horizontal (arc chamber top) or vertical	
Temperature				
Operating temperature	-40 °C ... +70 °C (85 °C)		40 °C ... +70 °C (85 °C)	
Storage temperature	-40 °C ... +85 °C		-40 °C ... +85 °C	
Auxiliary switch	Standard :1 pcs S880 (Change Over) Option: max. 2 pcs S880		Standard :1 pcs S880 (Change Over) Option: max. 2 pcs S880	

Schaltbau Contactors



1



2



3

Schaltbau Contactors

1. C165c Contactor N/O 24V S3272/24
2. C195s Contactor 48V S3278/48
3. C295 Contactor 24V – 220V C295 series

This is just a small selection, please visit our webpage for our full available range

(Do Not Scale)

RC 4 pole



EN 60077-1, EN 60077-2, EN 61373

Dimension diagram, circuit diagram

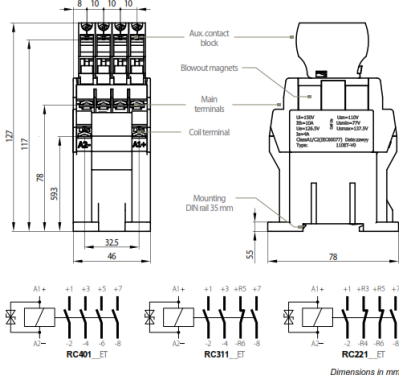

Dimensions in mm

Specifications

Series	RC221,311,401
Type of voltage	DC unidirectional
Main contacts	4 NO, 3 NO/1 NC, 2 NO/2 NC
Nominal voltage U_n	110 V
Rated operating voltage U_e	126.5 V
Rated insulation voltage U_{im}	150 V
Rated impulse withstand voltage U_{iw}	1.5 kV
Pollution degree	PD3
Ovoltage category	OV2
Conventional thermal current I_{th}	10 A
Auxiliary contacts	4x NO/NC max., silver, DC13/110V:0.5 A
Coil voltage U_c	24 / 36 / 72 / 110 V DC
Coil tolerance	-30% ... +25% U_c
Vibration / Shock (IEC 61373)	Class B, Category 1
Mounting position	horizontal / vertical
Temperature	-40° C ... +70° C
Mechanical endurance	> 2 million cycles

C193 SPST N/O Contactor



Conv. thermal current 50 A
Nominal voltage 1,000 V
Single pole single throw

C195 X Contactor



Features

- Special **bidirectional** version for **AC and DC** applications
- Compact, rugged design
- Nominal voltage U_n **1,500 V**
- Conventional thermal current I_{th} **320A**
- Suitable for years of continuous duty
- Intended for high ambient temperatures
- Double-break contacts
- High breaking capacity
- Magnetic blowout
- Tested to railway standard IEC 60077

HB Contactors 1

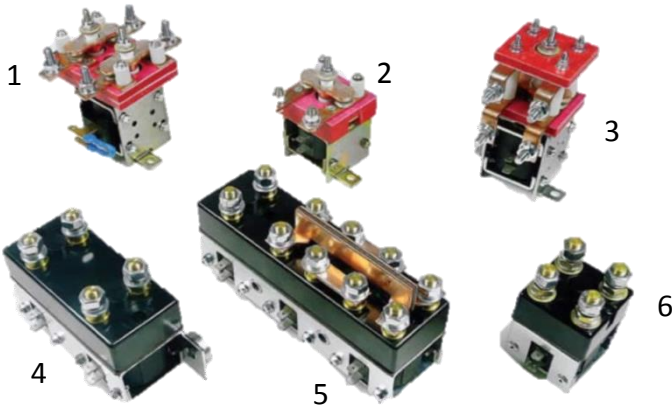

HB Contactor 1

- | | |
|-------------------------------------|-----------|
| 1. PE CONTACTOR DPST 200a 36v | E5007/36D |
| 2. PE CONTACTOR SPST 200A 24V | E5001/24D |
| 3. PE CONTACTOR SPDT 200a 24v | E5003/24 |
| 4. PE CONTACTOR 24V 2X SPST | E5102/24 |
| 5. PE CONTACTOR 24V 1X SPST 2X DPST | E5103/24 |
| 6. PE CONTACTOR DP 100A 24V | E5117/24 |

HB Contactors 2

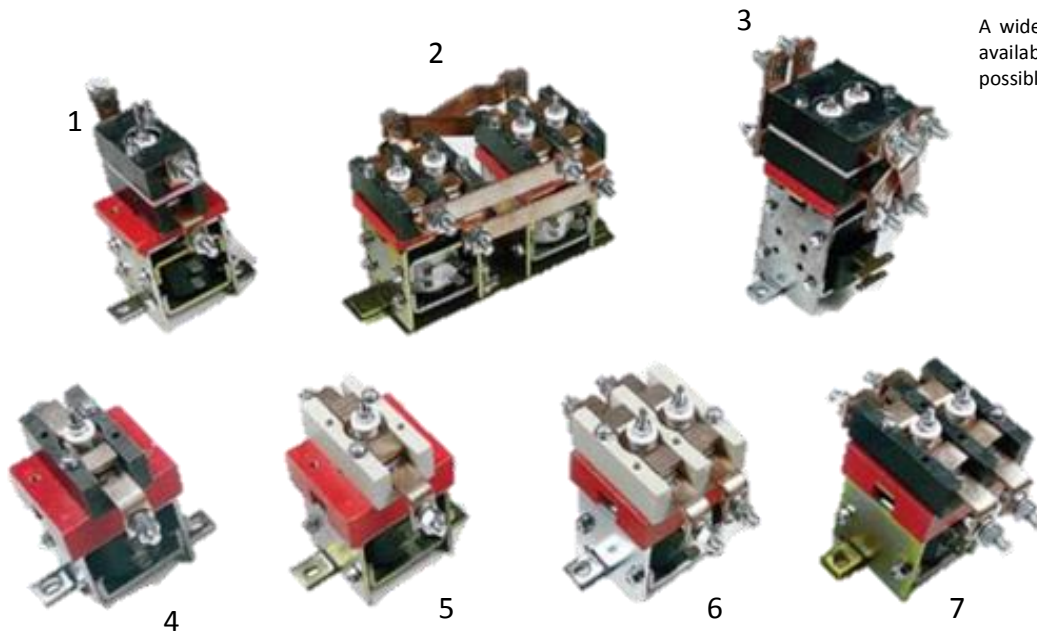

A wide variety of HB Contactors are available. Contact us for other possible configurations.

- | | |
|-----------------------------------|-----------|
| 1. PE CONTACTOR SPDT 100a 24v | E5403/24A |
| 2. PE CONTACTOR 2 x DPST 100a 36v | E5404/36B |
| 3. PE CONTACTOR 48v | E5409/48 |
| 4. PE CONTACTOR SPST 100A 24V | E5401/24E |
| 5. PE CONTACTOR SPST 150A 24V | E5431/24B |
| 6. PE CONTACTOR DPST 150A 48V CO | E5437/48C |
| 7. PE CONTACTOR DPST 100A 24V | E5407/24A |

Solenoids



Solenoids

1. BOSCH SOL 24V (TERM-FASTON)	A3101
2. SOLENOID 12V Ag ESSEX	A3137
3. BOSCH SOL 12V (V TERM-SCREW)	A3133
4. BOSCH SOL 24V (V TERM-SCREW)	A3125
5. SOLENOID PRESTOLITE 12V CURVED	A3136
6. SOLENOID 24V CURVED MOUNT	A3139
7. SOLENOID 80A 12V Cu	A3164
8. SOLENOID 24v FLAT MOUNT	A3130
9. SOLENOID 36V FLAT MOUNT	A3146

Cableform Contactors

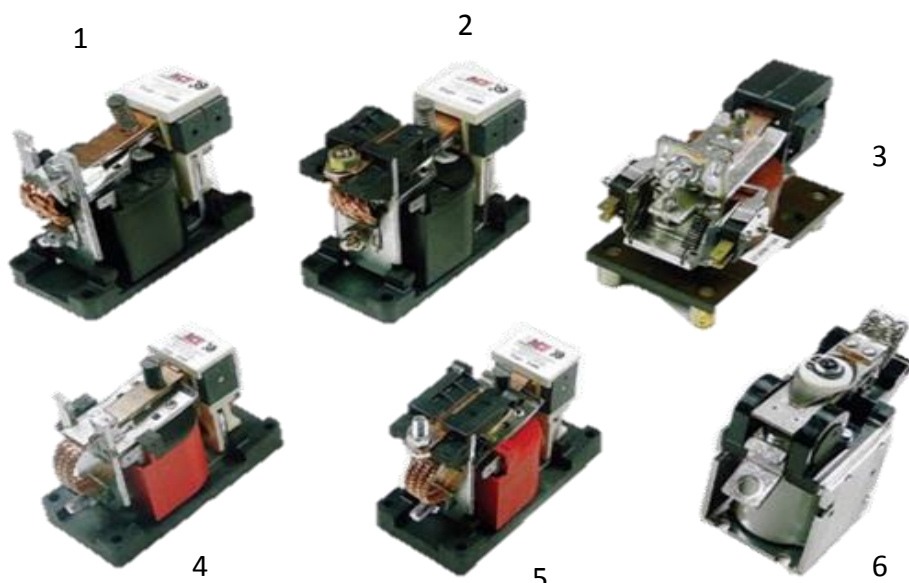

1. 1400 SERIES SPST	CC1421-1-1-12
2. 1400 SERIES SPDT	CC1422-1-1-48
3. 1100 SERIES SPST	CF3006/110A
4. 1300 SERIES SPST	CCA1321-1-1-12
5. 1300 SERIES SPDT	CCA1322-1-1-24
6. 1000 SERIES SPST	CF3001/24

Cam Contactors

C153



C155



C159



Standards

Series C152 ... C159

For requirements of industrial applications according to:
IEC 60947-1 Low-voltage switchgear and controlgear - Part 1: General rules

IEC 60947-4-1 Low-voltage switchgear and controlgear - Part 4-1: Contactors and motor starters, electromechanical contactors and motor starters

For requirements of railway applications according to:
IEC 60077-1, Railway applications - Electric equipment for rolling stock, Part 1: General service conditions and general rules

IEC 60077-2, Railway applications - Electric equipment for rolling stock, Part 2: Electrotechnical components - General rules

Example **C155 N20-S-110EV-G3-P**

Series + type of main contact

Series	# of contacts	Cam switch element	Conv. thermal current	Blowout
C152 K	2 pole	S306 K	$I_n = 160$ A	---
C152 A		S306 A	$I_n = 200$ A	---
C152 M		S306 M	$I_n = 160$ A	•
C152 C		S306 C	$I_n = 200$ A	•
C153 K	3 pole	S306 K	$I_n = 160$ A	---
C153 A		S306 A	$I_n = 200$ A	---
C153 M		S306 M	$I_n = 160$ A	•
C153 C		S306 C	$I_n = 200$ A	•
C154 K	4 pole	S306 K	$I_n = 160$ A	---
C154 A		S306 A	$I_n = 200$ A	---
C154 M		S306 M	$I_n = 160$ A	•
C154 C		S306 C	$I_n = 200$ A	•
C155 E	2 pole	S307 E	$I_n = 250$ A	---
C155 D		S307 A	$I_n = 300$ A	---
C155 G		S307 G	$I_n = 250$ A	•
C155 F		S307 C	$I_n = 300$ A	•
C155 N		S307 G/N*	$I_n = 250$ A	•
C155 P		S307 C/N*	$I_n = 300$ A	•
C156 E	3 pole	S307 E	$I_n = 250$ A	---
C156 D		S307 A	$I_n = 300$ A	---
C156 G		S307 G	$I_n = 250$ A	•
C156 F		S307 C	$I_n = 300$ A	•
C156 N		S307 G/N*	$I_n = 250$ A	•
C156 P		S307 C/N*	$I_n = 300$ A	•
C157 E	4 pole	S307 E	$I_n = 250$ A	---
C157 D		S307 A	$I_n = 300$ A	---
C157 G		S307 G	$I_n = 250$ A	•
C157 F		S307 C	$I_n = 300$ A	•
C157 N		S307 G/N*	$I_n = 250$ A	•
C157 P		S307 C/N*	$I_n = 300$ A	•
C158 R	1 pole	S310 A	$I_n = 500$ A	---
C158 S		S310 C	$I_n = 500$ A	•
C159 R	2 pole	S310 A	$I_n = 500$ A	---
C159 S		S310 C	$I_n = 500$ A	•

Number and configuration of main contacts

1st digit # of NO contacts } see table opposite:
2nd digit # of NC contacts } Overview main contacts

Arc chamber/arc chute

L	LK-S306; arc chamber for S306
M	LK-S307; arc chamber for S307
N	LK-S309; arc chamber for S307, with mounting screw
P	LK-S307-DC; arc chute for S307 C/N, S307 G/N
O	LK-S310; arc chamber for S310, with mounting screw

Number and configuration of auxiliary contacts

Cam switch elements

1st digit # of NO contacts } see table opposite:
2nd digit # of NC contacts } Overview aux. contacts

Snap-action switch

1st digit # of snap switches } see table opposite:
Overview aux. contacts

Auxiliary contacts (type + # of)

X	Cam switch element S007 A; $I_n = 15$ A
G	Snap-action switch S826 a, Screw-type terminals; $I_n = 10$ A
K	Snap-action switch S826 a 20, Flat tabs 90° angled; $I_n = 10$ A
T	Snap-action switch S800 a, Screw-type terminals; $I_n = 10$ A

Coil suppression

V	Varistor (only with economy resistor)
X	None (with electronic economy circuit)

Coil tolerance

E	+25% ... -30%
F	+25% ... -10%

Coil voltage

with economy resistor

12/24/48/72/96/110/220	V DC
with electronic economy circuit	
24/64/110	V DC

Economy circuit

S	Economy resistor
E	Electronic economy circuit

Schaltbau Emergency Stop Switches

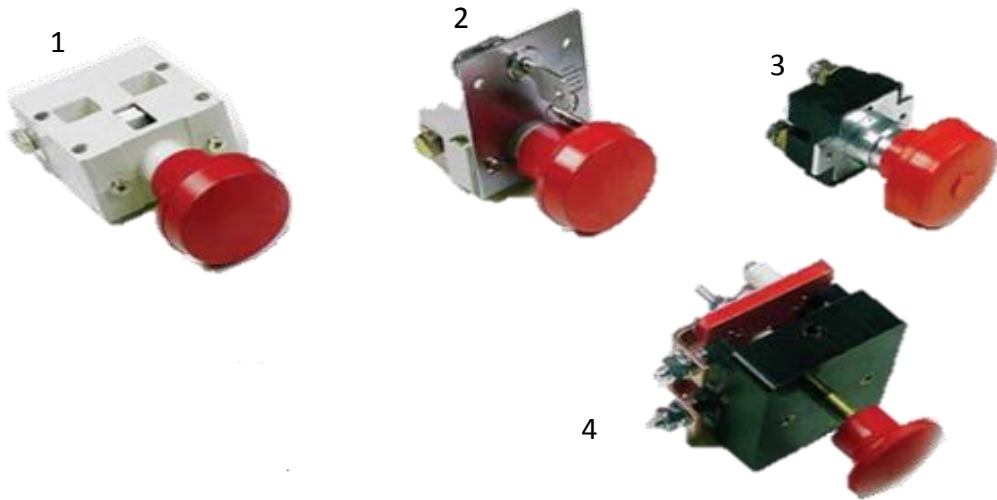

- 1. S134 SWITCH
- 2. S132 SWITCH + LOCK ASSEMBLY
- 3. 40050P EMERGENCY SWITCH
- 4. EM STOP SWITCH 200Amp SHORT SHAFT

- S3722
- S3723/2
- L4624/01
- E5200/A

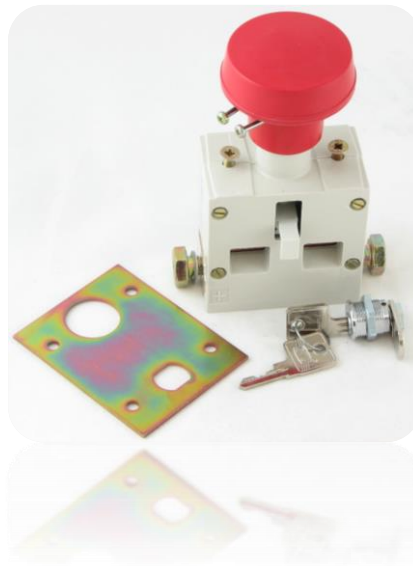

1

2

- 1. S134 SWITCH + LOCK ASSEMBLY S3722/3
- 2. S134 SWITCH FOR AUX & LOCK S3722/2



AFS Contact Kits

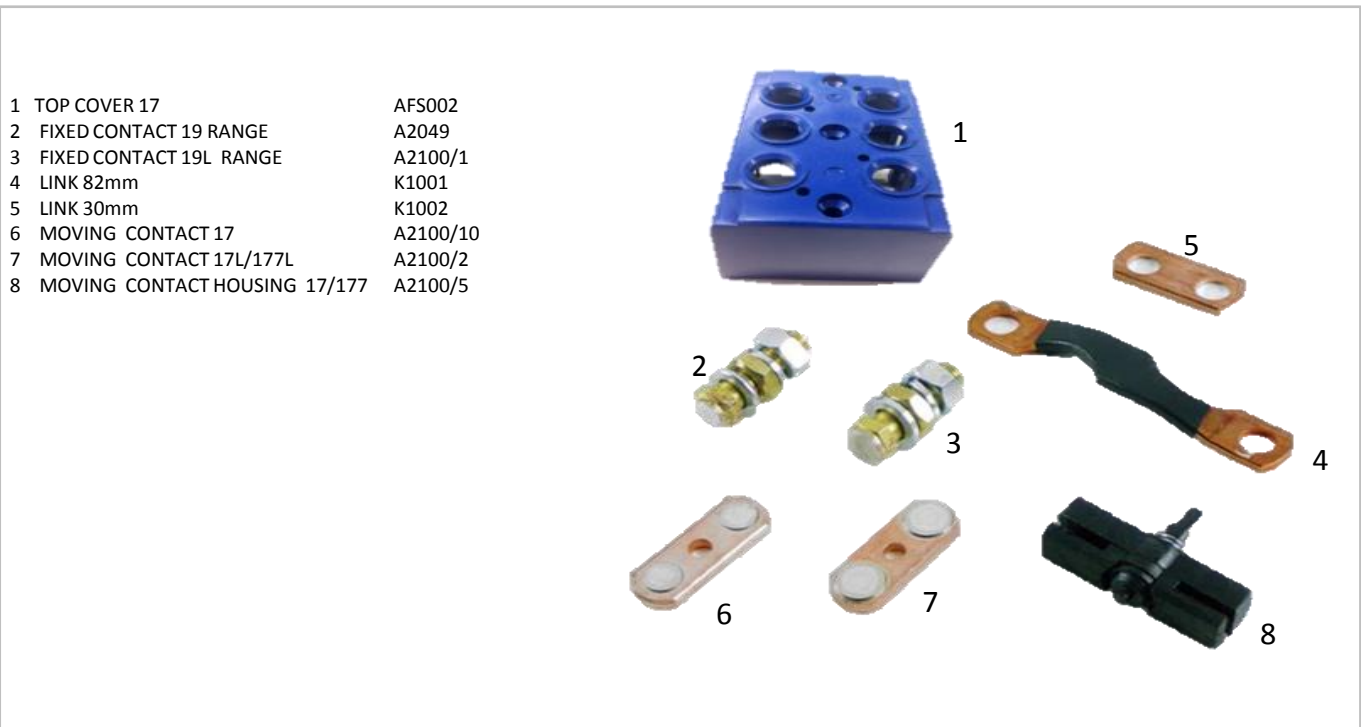
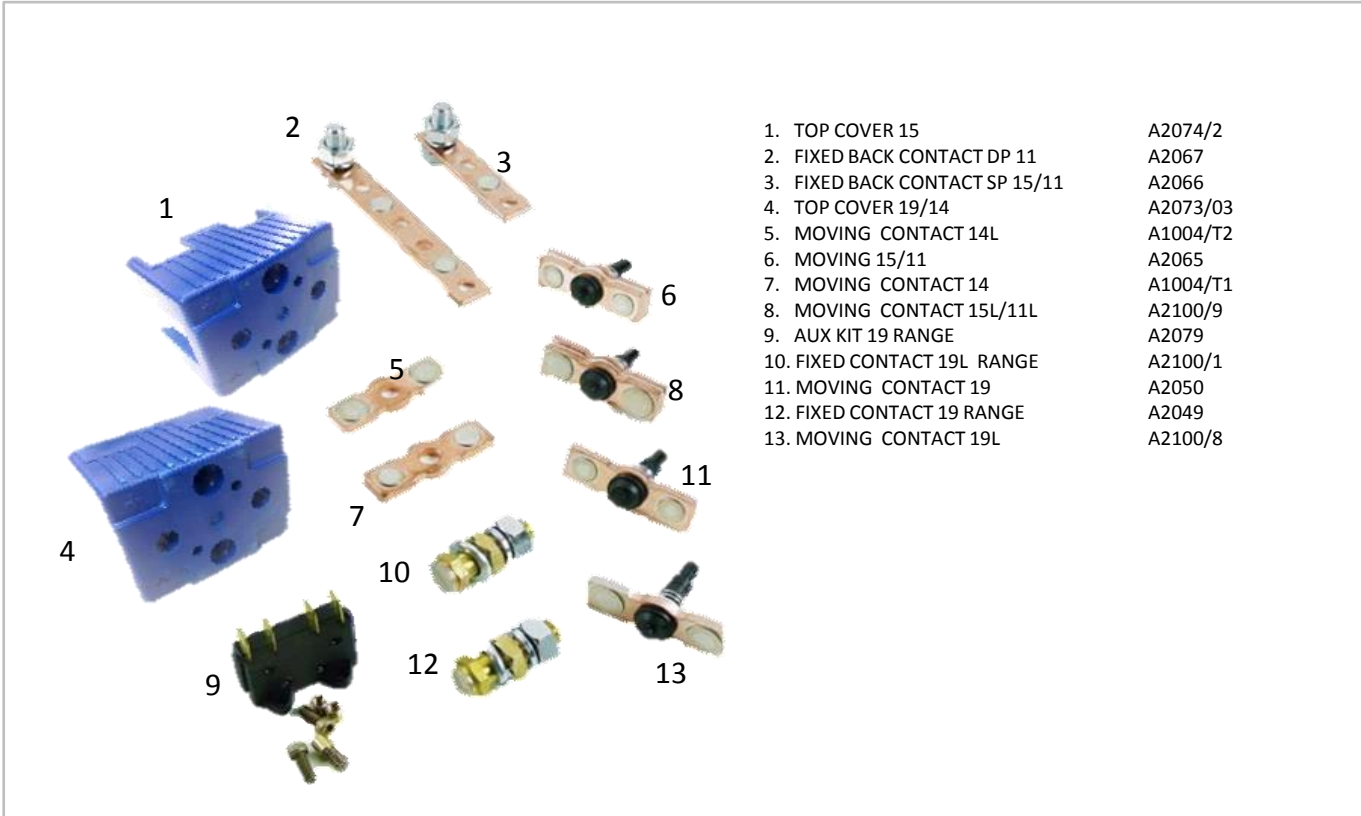

AFS Contact Kits

AFS Contacts – 711, 711L

- | | |
|---------------------------|----------|
| 1. TOP COVER DC288L RH | A2112/5 |
| 2. MOVING CONTACT 15/11 | A2065 |
| 3. MOVING CONTACT 15L/11L | A2100/9 |
| 4. FIXED CONTACT 711 | A2108/2 |
| 5. AUX KIT 711 RANGE | A2079/01 |
| 6. CONTACT INSULATOR 711 | A2108/3 |

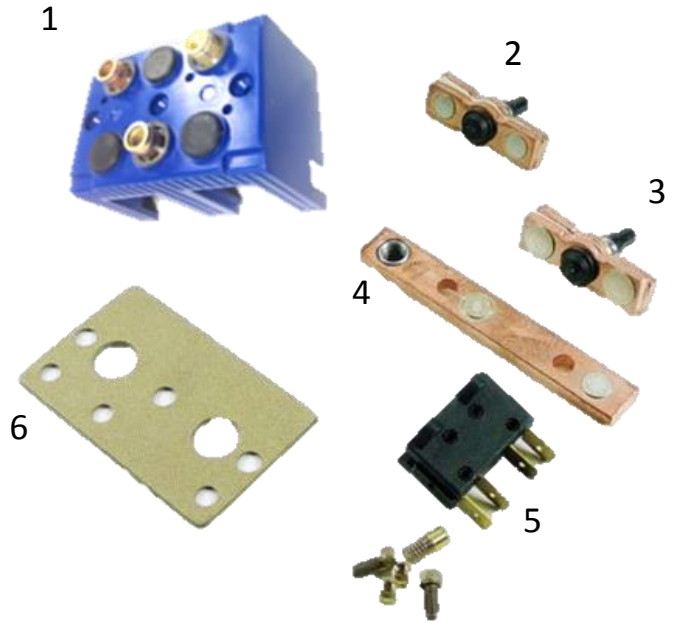

AFS Contacts – 717, 717L

- | | |
|-----------------------------|----------|
| 1. TOP COVER 717 LH | A2109/1 |
| 2. FIXED CONTACT 717 | A2109/2 |
| 3. CONTACT INSULATOR 717 | A2109/3 |
| 4. MOVING CONTACT 818L/817L | A2096/1 |
| 5. MOVING CONTACT 818/817 | A2096/2 |
| 6. AUX KIT 819/819 RANGE | A2080/01 |

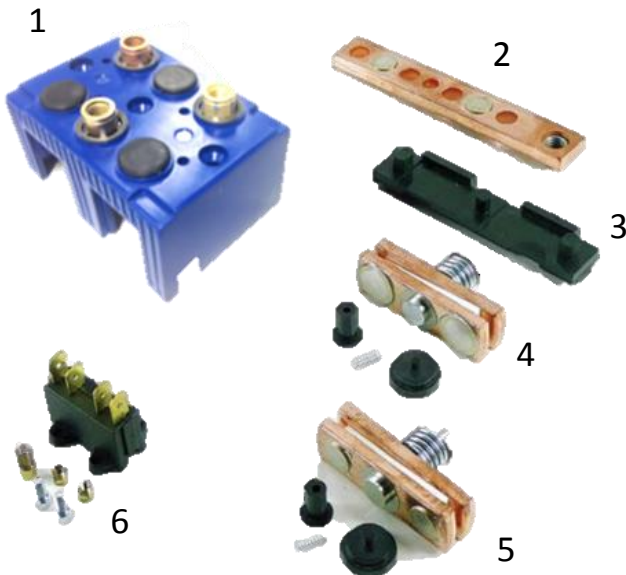

AFS Contact Kits



AFS Contacts 784, 789

- | | |
|-----------------------------|----------|
| 1. TOP COVER 798/797/784 | A2077/01 |
| 2. TOP COVER 799/789 | A2078/4 |
| 3. FIXED BACK CONTACT SP798 | A2058/01 |
| 4. BASE MOULDING 789/784 | A2078/9 |
| 5. AUX KIT 799 RANGE | A2081 |
| 6. MOVING CONTACT FOR 784 | A1006/T5 |
| 7. FIXED CONTACT 799 RANGE | A2053 |
| 8. MOVING CONTACT FOR 789 | A1006/T4 |
| 9. SPRING AND BUSH KIT 784 | A2142/03 |



AFS Contacts 799, 798, 797

- | | |
|------------------------------|--------|
| 1. TOP COVER 799/789 | A2078/ |
| 2. FIXED CONTACT 799 RANGE | A2053 |
| 3. TOP COVER 798/797/784 | A2077/ |
| 4. FIXED BACK CONTACT DP 797 | A2057 |
| 5. FIXED BACK CONTACT SP 798 | A2058 |
| 6. MOVING CONTACT 799 | A2054 |
| 7. MOVING CONTACT 798 | A2056 |
| 8. AUX KIT 799 RANGE | A2081 |

AFS Contact Kits

AFS Contacts – 807, 809

- | | |
|------------------------------------|---------|
| 1. TOP COVER 809/807 | A2117/1 |
| 2. FIXED CONTACT 819 | A2094/2 |
| 3. FIXED CONTACT 819L | A2094/1 |
| 4. AUX KIT AFS809 RANGE | A2119 |
| 5. LINK AFS809 | A2117/2 |
| 6. LINK AFS809 | A2117/3 |
| 7. Moving CONTACT ASSEMBLY AFS809L | A2117/6 |
| 8. Moving CONTACT ASSEMBLY AFS809 | A2117/5 |

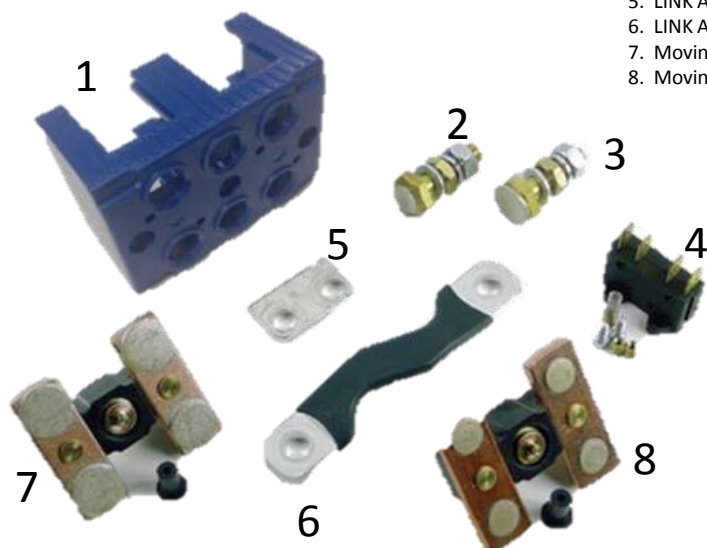

AFS Contacts - 814

- | | |
|-----------------------------|----------|
| 1. TOP COVER 819/814 | A2098/4 |
| 2. FIXED CONTACT 819L RANGE | A2094/1 |
| 3. FIXED CONTACT 819 RANGE | A2094/2 |
| 4. AUX KIT 819/817 RANGE | A2080/01 |
| 5. MOVING CONTACT FOR 814L | A1007/T1 |
| 6. MOVING CONTACT FOR 814 | A1007/T2 |

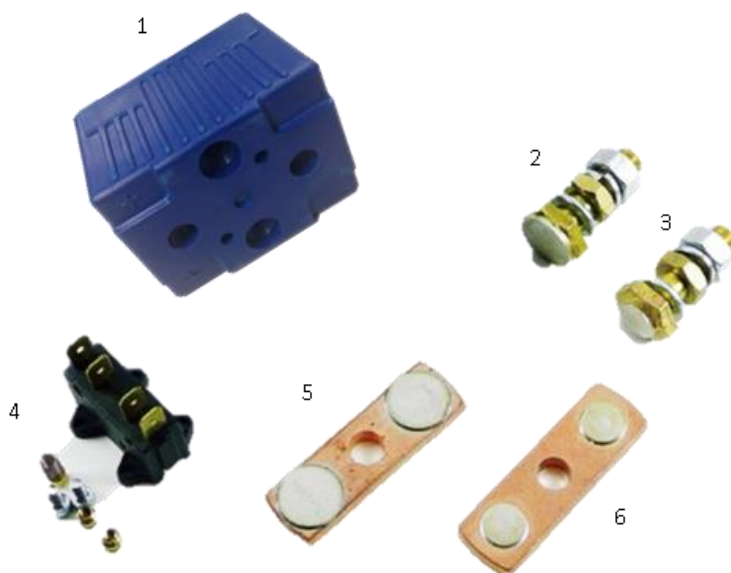

AFS Contact Kits

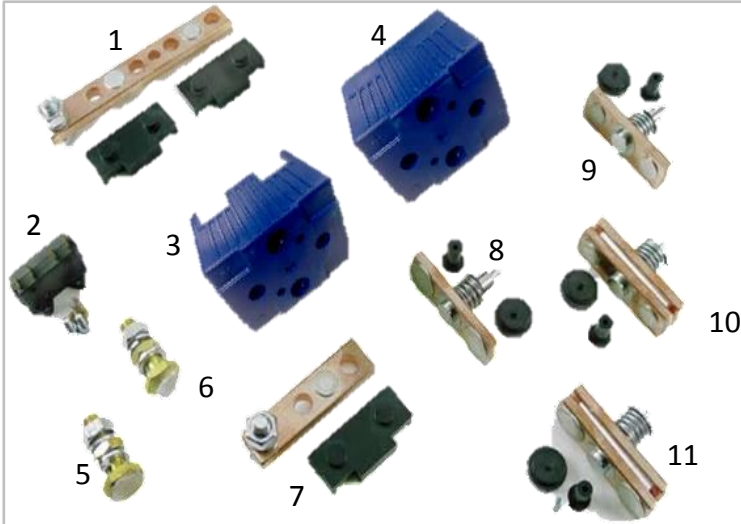

AFS Contacts – 817, 818, 819, 817L,

- | | |
|-----------------------------|----------|
| 1. FIXED BACK CONTACT DP817 | A2097/2 |
| 2. AUX KIT 819/717 RANGE | A2080/01 |
| 3. TOP COVER 817 | A2098/7 |
| 4. TOP COVER 819 | A2098/4 |
| 5. FIXED CONTACT 819L | A2094/1 |
| 6. FIXED CONTACT 819 | A2094/2 |

AFS818L, 819L

- | | |
|----------------------------------|---------|
| 7. FIXED BACK CONTACT SP 818/817 | A2097/1 |
| 8. MOVING CONTACT 819L | A2095/1 |
| 9. MOVING CONTACT 819 | A2095/2 |
| 10. MOVING CONTACT 818/817 | A2096/2 |
| 11. MOVING CONTACT 818L/817L | A2096/1 |



AFS Contacts – 899, 898, 897

- | | |
|------------------------------|---------|
| 1. FIXED BACK CONTACT DP 897 | A2064 |
| 2. MOVING CONTACT 899 | A2052 |
| 3. TOP COVER BASE 879/898 | A2055/1 |
| 4. AUX KIT 899 RANGE | A2080 |
| 5. FIXED CONTACT 899 RANGE | A2051 |
| 6. FIXED BACK CONTACT SP 898 | A2063 |
| 7. MOVING CONTACT 898/897 | A2062 |

Contactor Repair Kits	
Contactor Series	Kit Part no
AFS11 Contact Kit	A2070
AFS15 Contact Kit	A2069
AFS19 Contact Kit	A2046
AFS17 Contact Kit	A2100/K15
AFS711 Contact Kit	A2110
AFS717 Contact Kit	A2111
AFS784 Contact Kit	A2142/01
AFS789 Contact Kit	A2141/01
AFS799 Contact Kit	A2040
AFS798 Contact Kit	A2068
AFS797 Contact Kit	A2045
AFS809 Contact Kit	A2117/7
AFS807 Contact Kit	A2117/9
AFS814 Contact Kit	A2139/01
AFS817 Contact Kit	A2103/3
AFS818 Contact Kit	A2103/2
AFS819 Contact Kit	A2103/1
AFS899 Contact Kit	A2048
AFS898 Contact Kit	A2071
AFS897 Contact Kit	A2072

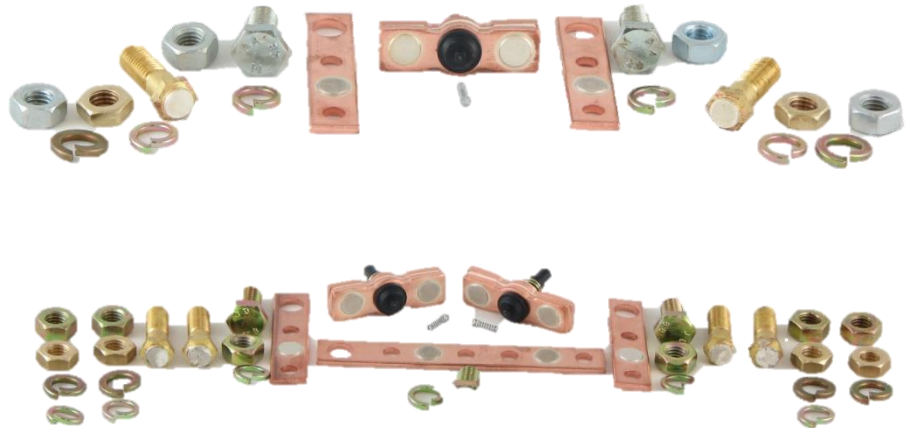

Other OEM Manufacturers numbers are used for Reference purpose only.

AFS Contact Spares

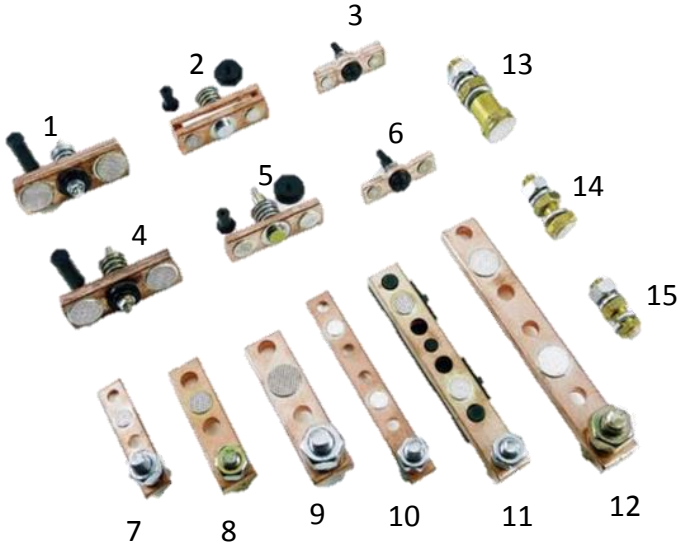

Textured

1. TEXT MOVING 798	A2056/4
2. TEXT MOVING 818/817	A2096/8
3. TEXT MOVING 15/11	A2065/02
4. TEXT MOVING 799	A2054/4
5. TEXT MOVING 819 TYPE	A2095/4
6. TEXT MOVING 19	A2050/02
7. TEXT FIXED SP 15	A2066/01
8. TEXT FIXED SP 818/7	A2097/3
9. TEXT FIXED SP 798	A2058/04
10. TEXT FIXED DP 11	A2067/02
11. TEXT FIXED DP 817	A2097/4
12. TEXT FIXED DP 797	A2057/04
13. TEXT FIXED 799	A2053/04
14. TEXT FIXED 819	A2094/5
15. TEXT FIXED 19	A2049/03

Brackets and Links

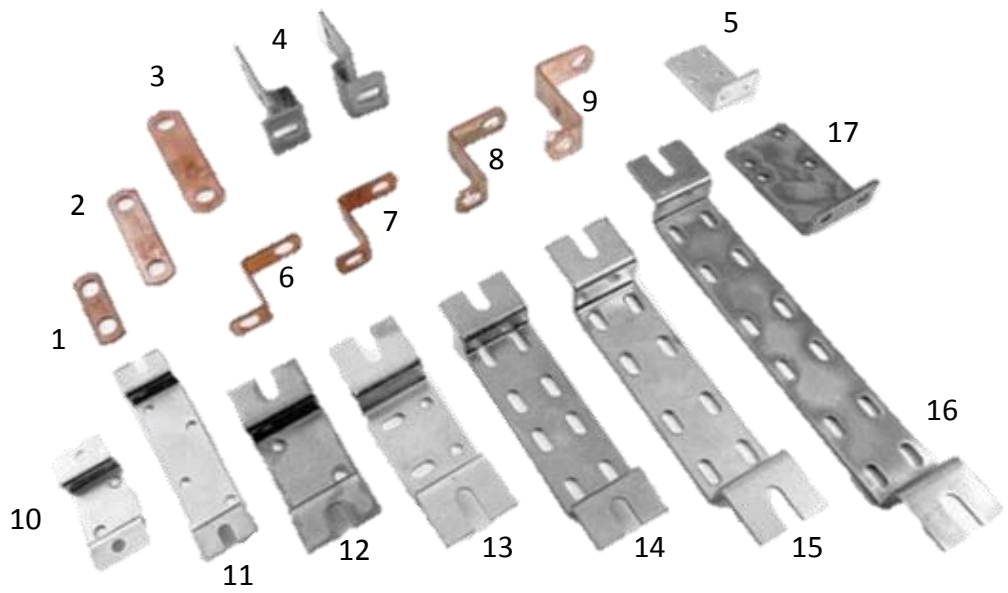

1. STRAIGHT LINK	A3152/S1	10. AFS19 SIDE FIXING	A3150/B1
2. 817/897 STRAIGHT LINK	A3152/S2	11. AFS11 SIDE FIXING	A3150/B2
3. 797 STRAIGHT LINK	A3152/S4	12. AFS899 SIDE FIXING	A3150/B8
4. AFS899 REAR FIXING	A3150/B10	13. AFS799 SIDE FIXING	A3150/B9
5. 19 VERTICAL FIXING	A3150/B7	14. AFS897 SIDE FIXING	A3150/B3
6. 11 CRANKED LINK	A3152/C1	15. AFS797 SIDE FIXING	A3150/B4
7. 197 CRANKED LINK	A3152/C2	16. AFS799 3 STAGE SIDE	A3150/B5
8. 817 CRANKED LINK	A3152/C3	17. 899/799 VERTICAL FIXING	A3150/B6
9. 797 CRANKED LINK	A3152/C4	BRACKETS 4, 5, 10-17 ARE SUPPLIED WITH SCREWS AND WASHERS	

Cableform Contactor Spares

1000 Parts

1. 1000 SERIES MOVING CONT KIT NO	F1519
2. 1000 SERIES BACK CONTACT	F1514
3. 1000 SERIES MOVING CONT KIT CO	F1520
4. 1000 SERIES MOULDING KIT	F1502
5. AUX KIT 1000 SER LH	CF4501
6. CONTACT ASSY CO 1000 SERIES	F3005
7. CONTACT ASSY NO 1000 SERIES	F3004
8. 1000 SERIES FIXED CONTACT	F1516

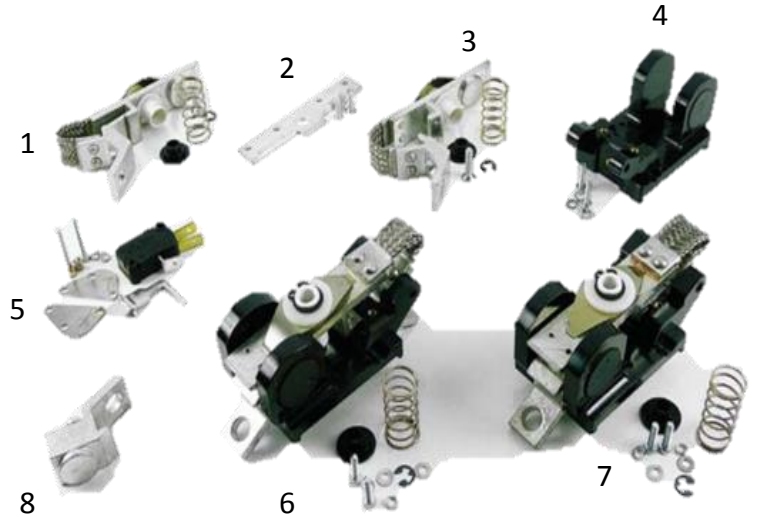

1100 Parts

1. BRAID SUPPORT ASSY 1100 SERIES	CF1518	8. 1100 SERIES FIXED CONTACT	F1505
2. 1100 SERIES ARMATURE ASSY NO	F1506	9. 1100 SERIES MOVING CONTACT NO	F1521
3. 1100 SERIES SPRING KIT	F1511	10. 1100 SERIES MOVING CONTACT CO	F1523
4. BLOW OUT PACK 1100 SERIES STD	CF1512	11. 1100 BACK CONT ASSY DP	1510
5. COIL 1100 SERIES	CF1004/V	12. 1100 BACK CONT ASSY SP LH	F1509
6. 1100 SERIES ARMATURE ASSY CO	F1507	13. 1100 BACK CONT ASSY SP RH	F1508
7. 1100 SERIES ARMATURE PLATE	F1522	14. AUX KIT 1100 SER RH	CF4504

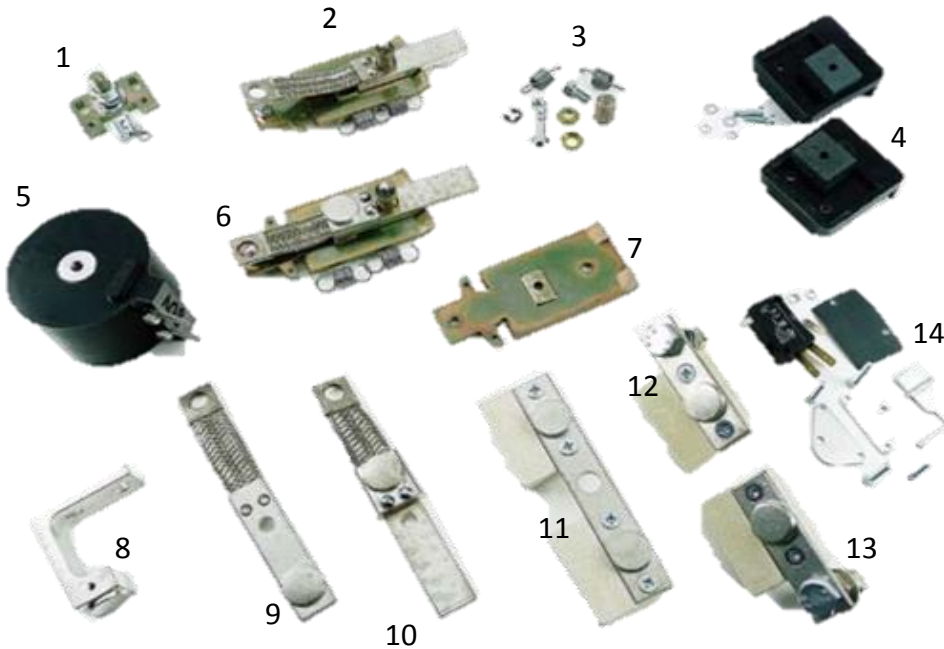

Cableform Contactor Spares

1200 Parts

1 CONTACT ASSY 1200 C/O	CC14588
2 BACK CONTACT ASSY DT 1200	CC14582
3 SPRING KIT 1200	CC14575
4 CONTACT ASSY 1200 N/O	CC14576
5 FIXED CONTACT 1200	CC14344



1300 Parts

1 BLOWOUT ASSY A1300	CC19572
2 1300 FIXED FRONT CONTACT	CC16324
3 1300 FIXED BACK CONTACT	CC16325
4 1300 DT MOVING CONTACT	CC16327
5 REAR MOULDING 1300 PAIR LH+RH	CC16299
6 TOP SPRING STUD 1300	CC16309
7 ARMATURE PLATE ASSY (A1300)	CC16420
8 COMPRESSION SPRING 1300	CC16310
9 ARMATURE PLATE RETAINER 1300	CC16305
10 1300 ST MOVING CONTACT	CC16326
11 BRAID 1300	CC16302

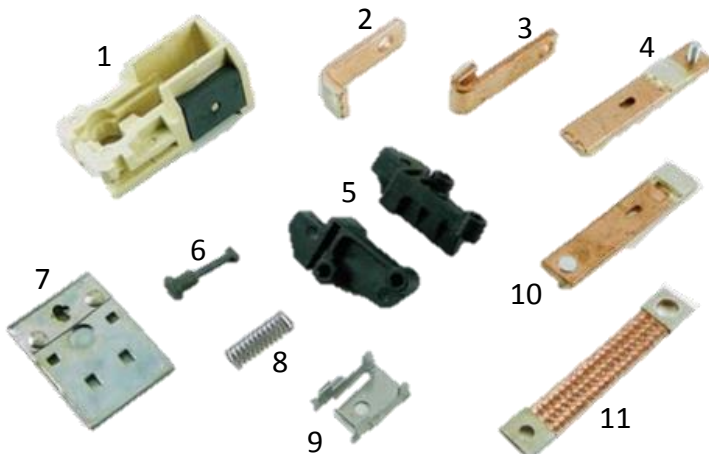

1400 Parts

1 BLOWOUT ASSY 1400	CC19576
2 1400 FIXED FRONT CONTACT	CC17341
3 1400 FIXED BACK CONTACT	CC17343
4 1400 DT MOVING CONTACT	CC17347
5 REAR MOULDING (1400) PAIR	CC17334
6 SPRING STUD	CC17354
7 ARMATURE PLATE ASSEMBLY	CC18079
8 SPRING	CC17355
9 CATCH SHIM	CC17766
10 1400 ST MOVING CONTACT	CC17345
11 BRAID 1400 SERIES	C17351
12 SPACER PHOSPHATED (1400)	CC17353

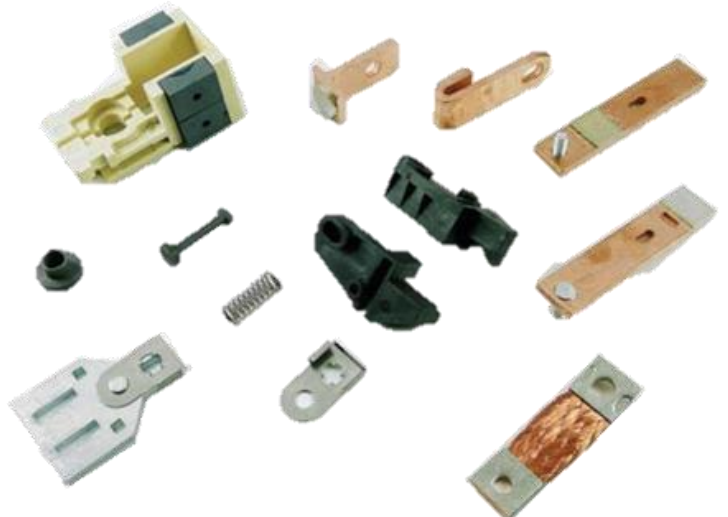

GE / EV1 Contacts

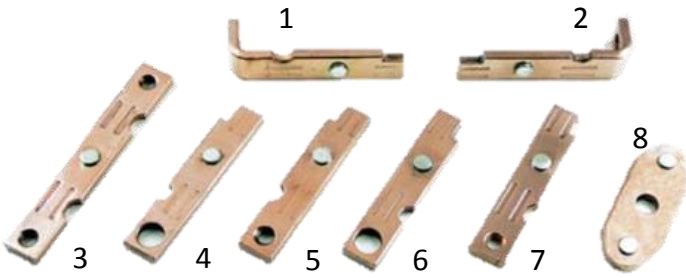

GE EV1

1	EV1 FIXED CONTACT 150A S	E2404
2	EV1 FIXED CONTACT 150A S	E2403
3	EV1 FIXED CONTACT 150A S	E2401
4	EV1 FIXED CONTACT 150A S	E2400
5	EV1 FIXED CONTACT 150A S	E2399
6	EV1 FIXED CONTACT 150A S	E2394
7	EV1 FIXED CONTACT 150A S	E2402
8	EV1 MOVING CONTACT 150A S	E2398

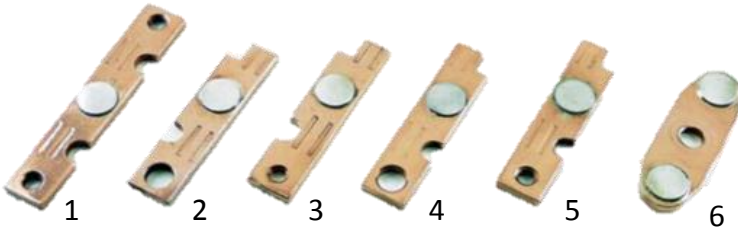

GE EV1

1	EV1 FIXED CONTACT 300A L	E2396
2	EV1 FIXED CONTACT 300A L	E2520/2
3	EV1 FIXED CONTACT 300A L	E2408
4	EV1 FIXED CONTACT 300A L	E2520/1
5	EV1 FIXED CONTACT 300A L	E2391
6	EV1 MOVING CONTACT 300A L	E2393

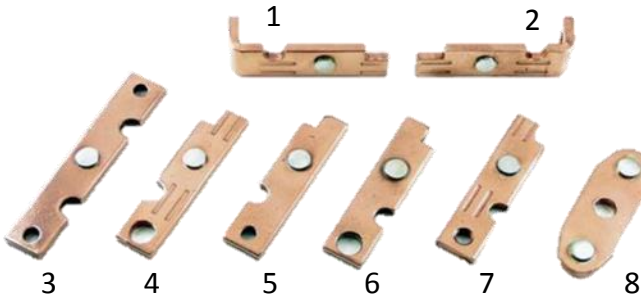

GE EV1

1	EV1 FIXED CONTACT 300A S	E2432
2	EV1 FIXED CONTACT 300A S	E2431
3	EV1 FIXED CONTACT 300A S	E2429
4	EV1 FIXED CONTACT 300A S	E2428
5	EV1 FIXED CONTACT 300A S	E2434
6	EV1 FIXED CONTACT 300A S	E2433
7	EV1 FIXED CONTACT 300A S	E2430
8	EV1 MOVING CONTACT 300A S	E2427

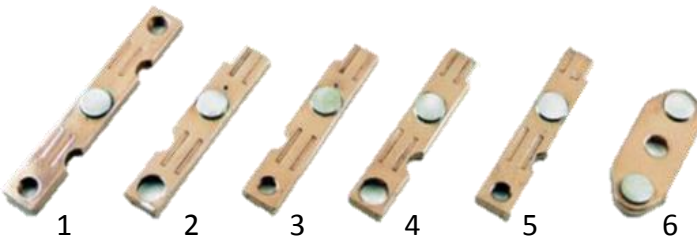

GE EV1

1	EV1 FIXED CONTACT 150A L	E2395
2	EV1 FIXED CONTACT 150A L	E2519/2
3	EV1 FIXED CONTACT 150A L	E2411
4	EV1 FIXED CONTACT 150A L	E2519/1
5	EV1 FIXED CONTACT 150A L	E2410
6	EV1 MOVING CONTACT 150A L	E2392

GE / EV1 Contacts

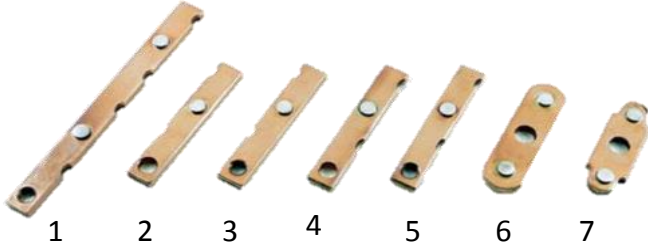

GE EV100

1	EV100 FIXED CONTACT 150A	S	E2504
2	EV100 FIXED CONTACT 150A	S	E2507
3	EV100 FIXED CONTACT 150A	S	E2506
4	EV100 FIXED CONTACT 150A	S	E2508
5	EV100 FIXED CONTACT 150A	S	E2509
6	EV100 MOVING CONTACT 150A	S	E2505/1
7	EV100 MOVING CONTACT 150A	S	E2505

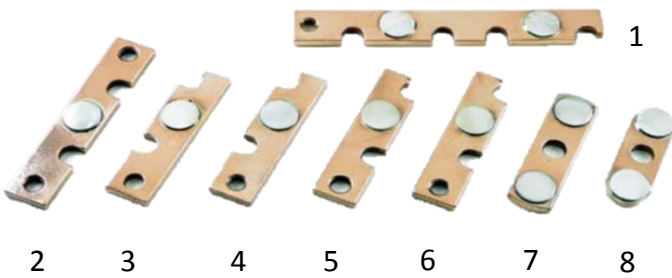

GE EV100

1	EV100 FIXED CONTACT 300A	L	E2517/1
2	EV100 FIXED CONTACT 300A	L	E2517
3	EV100 FIXED CONTACT 300A	L	E2517/4
4	EV100 FIXED CONTACT 300A	L	E2517/5
5	EV100 FIXED CONTACT 300A	L	E2517/2
6	EV100 FIXED CONTACT 300A	L	E2517/3
7	EV100 MOVING CONTACT 300A	L	E2516
8	EV100 MOVING CONTACT 300A	L	E2516/2

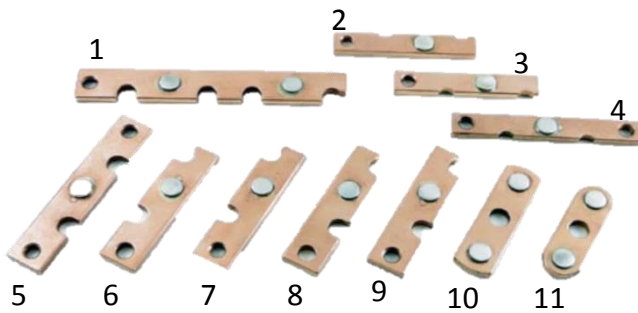

GE EV100

1	EV100 FIXED CONTACT 300A	S	E2514/1
2	EV100 FIXED CONTACT 300A	S	E2514/11
3	EV100 FIXED CONTACT 300A	S	E2514/10
4	EV100 FIXED CONTACT 300A	S	E2514/9
5	EV100 FIXED CONTACT 300A	S	E2514/8
6	EV100 FIXED CONTACT 300A	S	E2514/3
7	EV100 FIXED CONTACT 300A	S	E2514/5
8	EV100 FIXED CONTACT 300A	S	E2514/4
9	EV100 FIXED CONTACT 300A	S	E2514/6
10	EV100 MOVING CONTACT 300A	S	E2514/7
11	EV100 MOVING CONTACT 300A	S	E2514/2

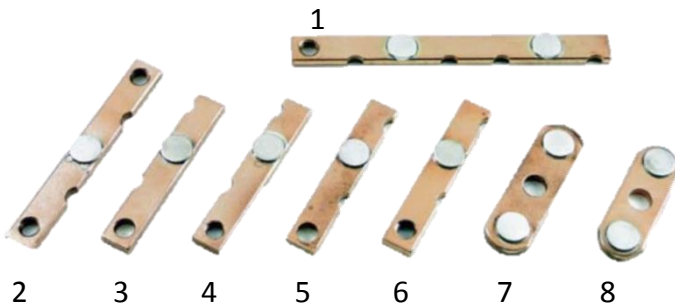

GE EV100

1	EV100 FIXED CONTACT 150A	L	E2518/1
2	EV100 FIXED CONTACT 150A	L	E2518/2
3	EV100 FIXED CONTACT 150A	L	E2518/4
4	EV100 FIXED CONTACT 150A	L	E2518/3
5	EV100 FIXED CONTACT 150A	L	E2518/6
6	EV100 FIXED CONTACT 150A	L	E2518/5
7	EV100 MOVING CONTACT 150A	L	E2521/1
8	EV100 MOVING CONTACT 150A	L	E2505/2

Contacts for Crown, Still, Nissan & Linde

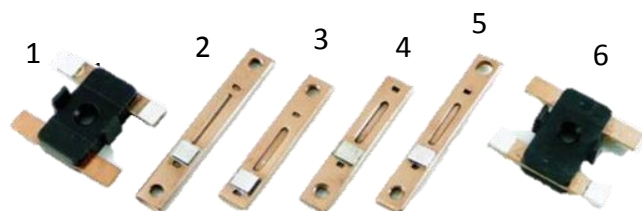

Crown Contacts AFS75 & 76

1 GE MOVING CONTACT SP	E2489/01
2 GE FIXED CONTACT	E2491
3 GE FIXED CONTACT	E2490
4 GE CONTACT BAR	E2444
5 GE FIXED CONTACT	E2445
6 GE MOVING CONTACT DP	E2443/01

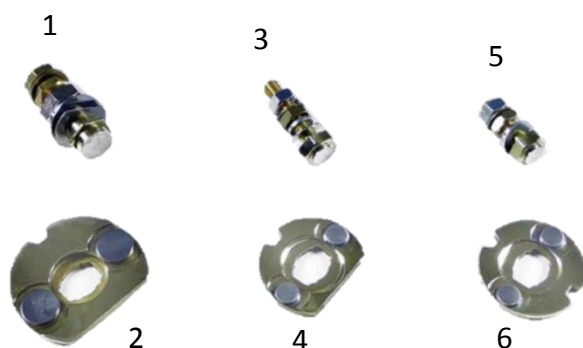

Replacement Contacts for Solenoid type

1 FIXED CONTACT	A2028
2 MOVING CONTACT	A2031
3 FIXED CONTACT 40mm	A2006/L
4 MOVING CONTACT	A2005
5 FIXED CONTACT	A2006/01
6 MOVING CONTACT	A2023/01

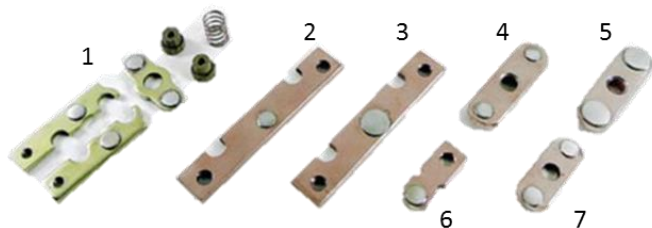

Nissan Contacts

1 CONTACT KIT-NISSAN	D1963/01
2 NISSAN CONTACT	D1930
3 NISSAN CONTACT	D1934
4 NISSAN CONTACT	D1933
5 NISSAN CONTACT	D1935
6 NISSAN CONTACT	D1932
7 NISSAN CONTACT	D1931

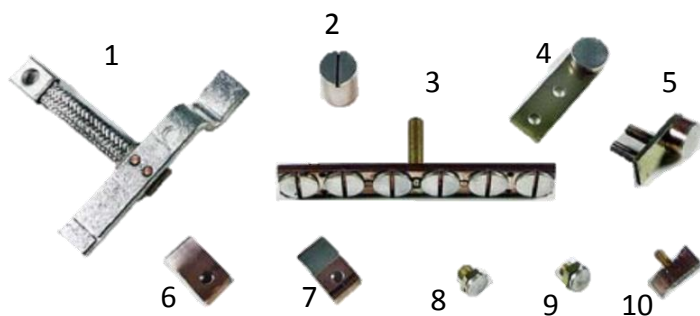

Still & Linde Contacts

1 MOVING CONTACT SPNO SQ. TIP	D1918
2 CYLINDRICAL FIXED CONTACT	D1914
3 FIXED 6 TIP CONTACT	D1911
4 MOVING FINGER CONTACT	D1912
5 MOVING CONTACT WITH 2 STUDS	D1913
6 STILL LINDE CONTACT Cu	V2526
7 STILL LINDE CONTACT AG	V2538
8 CONTACT (STUD)	V2545
9 STILL CONTACT (WITH STUD)	V2543
10 FIXED CONTACT WITH STUD	D1910

Japanese Contacts

Komatsu Contacts

1	FIXED CONTACT 16mm TIP	D1958/04A
2	FIXED CONTACT 16mm TIP	D1958/03A
3	MOVING CONTACT 16mm TIP	D1958/02A
4	NISSAN CONTACT	D1934
5	NISSAN CONTACT	D1930
6	NISSAN CONTACT	D1933
7	NISSAN CONTACT	D1935
8	CONTACT MOVING 7870203750	D1960/02
9	CONTACT MOVING 7870903560	D1961/02
10	NISSAN CONTACT	D1932
11	FIXED BACK CONTACT FBN38F40745	D1965/03
12	FIXED CONTACT 12mm TIP	D1958/03
13	FIXED CONTACT 12mm TIP	D1958/04
14	MOVING CONTACT 12mm TIP	D1958/02
15	CONTACT MOVING 7870203740	D1962/01
16	CONTACT FIXED 7870903530	D1961/01
17	NISSAN CONTACT	D1931
18	CONTACT KIT ST 10mm	D1955/05
19	CONTACT FIXED 7870203730	D1960/01
20	CONTACT KIT ST 8mm	D1955
21	MOVING CONTACT ASSY FBN38F40741	D1965/02

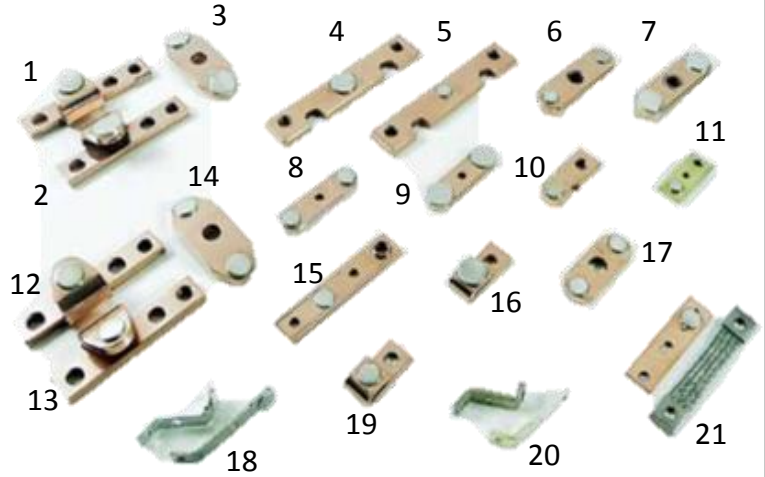

TCM Contacts

1	MOVING CONTACT SPNO SQ. TIP	D1918
2	FIXED CONTACT	D1936
3	FIXED CONTACT SMALL TIP	D1937
4	MOVING CONTACT C/O BPN38F40370	D1966/02
5	MOVING CONTACT N/O BPN38F40372	D1966/01
6	FIXED CONTACT BPN38F40371	D1966/06
7	MOVING CONTACT ABMSD41138	D1931/01
8	FIXED CONTACT SQ TIP	D1916
9	FXD CONTACT BPN38F40368 3mm	D1966/08
10	FIXED CONTACT BPN38F40369 1.5mm TIP	D1966/09

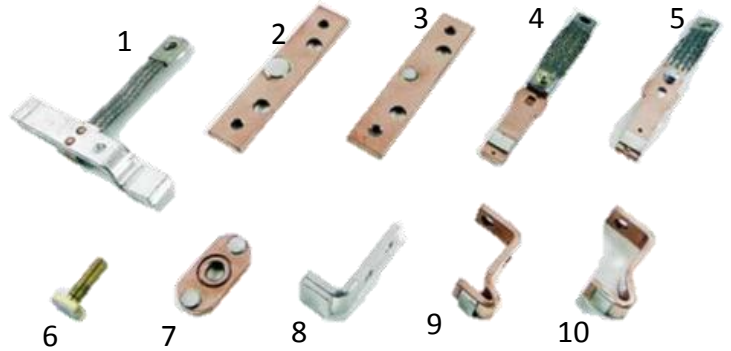

NYK Contacts

1	NYK CONTACT 0.5in-STUD	P2168
2	NYK CONTACT 0.625in-STUD	P2167
3	NYK CONTACT 0.5in-PLATE	P2177
4	NYK FXD CONTACT (FOR D1954/TYPE)	D1954/5
5	NYK FIXED CONTACT	P2173
6	CONTACT FIXED 8271-60280	D1953/2
7	BACK CONTACT DP	D1954/7
8	CONTACT BACK DP 8271-70050	D1953/4
9	CONTACT MOVING C/O 8271-70020	D1953/3
10	CONTACT MOVING N/O 8271-60161	D1953/1
11	NYK MOV CONTACT C/O + BRAID	D1954/4
12	NYK MOV CONTACT N/O + BRAID	D1954/3



Japanese Contacts

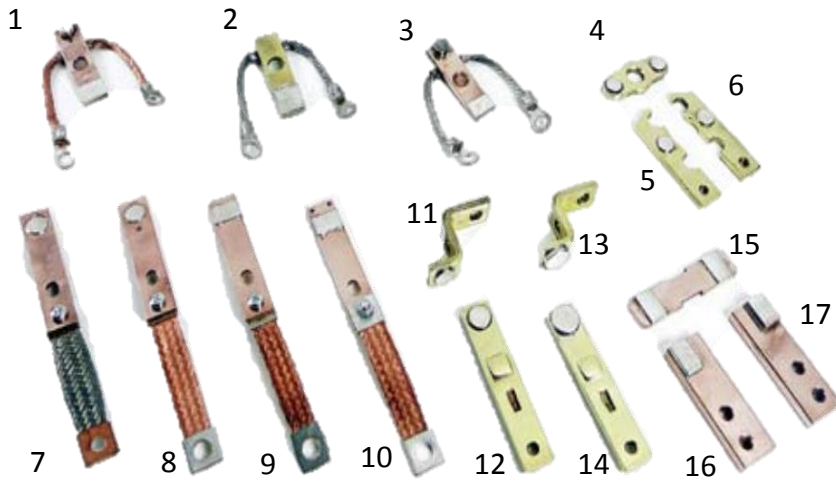

Toyota Contacts 1

1 CONTACT 24205-20390-71	D1940/1	9 CONTACT MOVING ASSY 24206-22500-71	D1952/5
2 CONTACT 24207-20390-71	D1940/2	10 TY MOV CONTACT REC TIP C/O 8mm BR	D1952/4
3 CONTACT 24206-20390-71	D1940	11 CONTACT FIXED 24418-11170-71 11mm	D1959/03
4 CONTACT MOVING 24143-11460-71	D1963/02	12 CONTACT MOVING C/O 24417-11170-71	D1959/04
5 CONTACT FIXED 24141-11460-71	D1963/04	13 CONTACT FIXED 24438-11170-71	D1959/02
6 CONTACT FIXED 24142-11460-71	D1963/03	14 CONTACT MOVING 24437-11170-71	D1959/01
7 TY MOV CONTACT RD TIP N/O 8mm BR	D1944/5	15 CONTACT 24314-11500-71	D1947/3
8 TY MOV CONTACT RD TIP C/O 8mm BR	D1944/1	16 CONTACT 24315-11590-71	D1947/1
		17 CONTACT 24316-11590-71	D1947/2

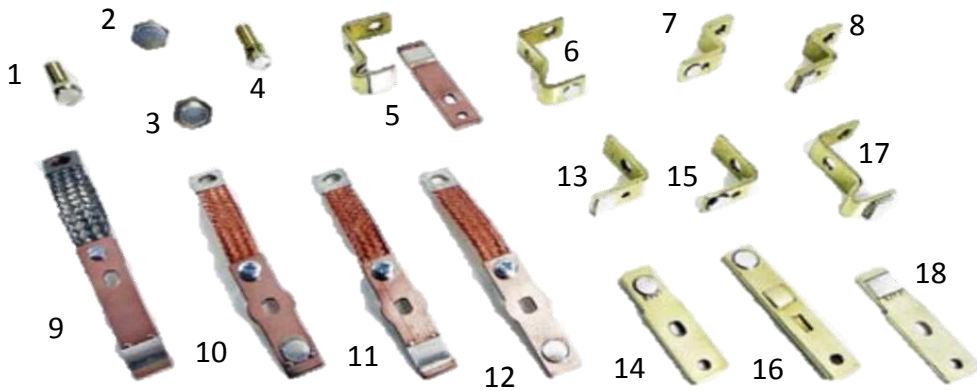

Toyota Contacts 2

1 CONTACT FIXED STUD 24412-11171-71	D1959/05	10 CONTACT MOVING DT 24412-12900-71	D1959/10
2 CONTACT 24431-11170-71	D1948/01	11 CONTACT MOVING ST 24422-12900-71	D1959/12
3 CONTACT 24411-11170-71	D1948	12 CONTACT MOVING ST 24431-12900-71	D1959/11
4 CONTACT FIXED 24413-12900-71	D1959/08	13 CONTACT FIXED 24421-12900-71	D1959/15
5 TOYOTA CONTACT KIT RECT TIPS	D1957	14 CONTACT MOVING DT 24412-13300-71	D1959/13
6 CONTACT FIXED 24219-22500-71	D1952/1C	15 CONTACT FIXED 24411-12900-71	D1959/09
7 CONTACT FIXED 24411-13300-71	D1959/06	16 CONTACT MOVING 24427-11170-71	D1959/07
8 CONTACT FIXED 24421-13300-71	D1959/14	17 CONTACT FIXED 24216-22500-71	D1952/1A
9 CONTACT MOVING ASSY 24303-22500-71	D1952/10	18 CONTACT MOVING ST 24422-13300-71	D1959/16

Keiki Contact Kits

- | | | |
|----|-----------------------------|----------|
| 1 | MOVING CONTACT ASSEMBLY C/O | D1967/02 |
| 2 | FIXED CONTACT C/O | D1967/04 |
| 3 | FIXED CONTACT C/O | D1967/05 |
| 4 | MOVING CONTACT ASSEMBLY N/O | D1967/01 |
| 5 | FIXED CONTACT N/O | D1967/03 |
| 6 | MOVING CONTACT ASSEMBLY N/o | D1968/01 |
| 7 | FIXED CONTACT N/O | D1968/03 |
| 8 | MOVING CONTACT ASSEMBLY C/O | D1968/02 |
| 9 | FIXED CONTACT C/O | D1968/04 |
| 10 | FIXED CONTACT C/O | D1968/05 |

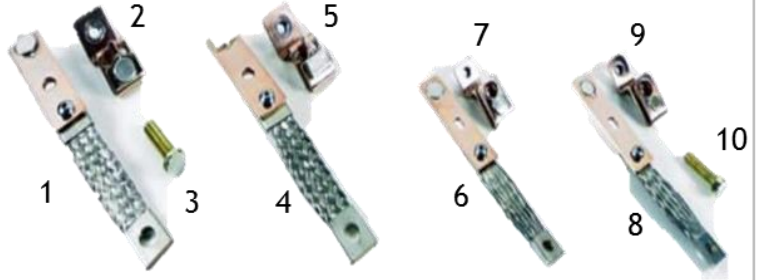

HB 100 A Contact Kits

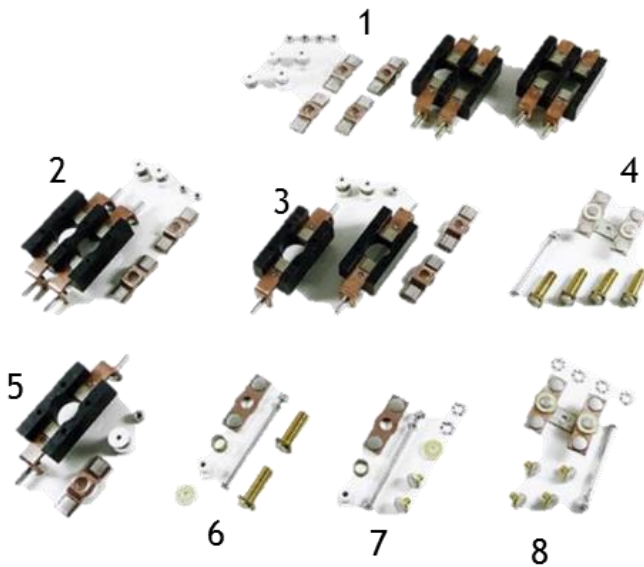

- | | | |
|---|----------------------|---------|
| 1 | HB CONTACT KIT HB409 | E2413/3 |
| 2 | HB CONTACT KIT HB407 | E2413 |
| 3 | HB CONTACT KIT HB403 | E2412/2 |
| 4 | HB CONTACT KIT HB117 | E2522/1 |
| 5 | HB CONTACT KIT HB401 | E2412 |
| 6 | HB CONTACT KIT HB111 | E2513 |
| 7 | HB CONTACT KIT SPST | E2498 |
| 8 | HB CONTACT KIT DPST | E2497 |

HB 150 A Contact Kits

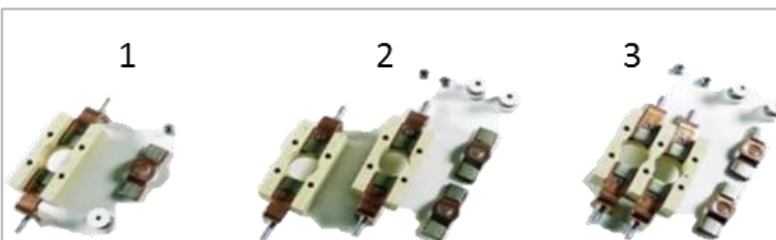

- | | | |
|---|----------------------|---------|
| 1 | HB CONTACT KIT HB431 | E2471 |
| 2 | HB CONTACT KIT HB433 | E2471/2 |
| 3 | HB CONTACT KIT HB437 | E2471/1 |



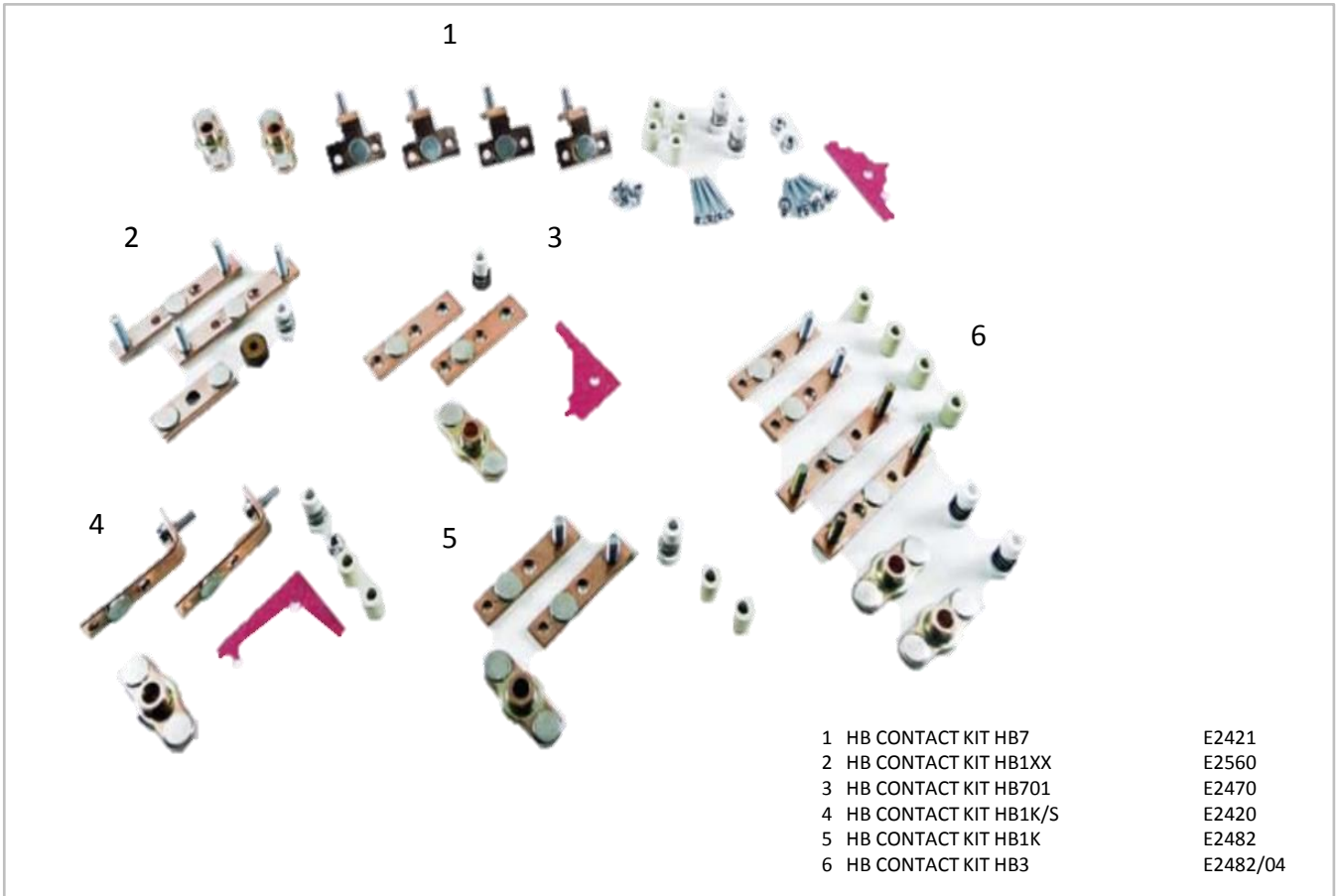

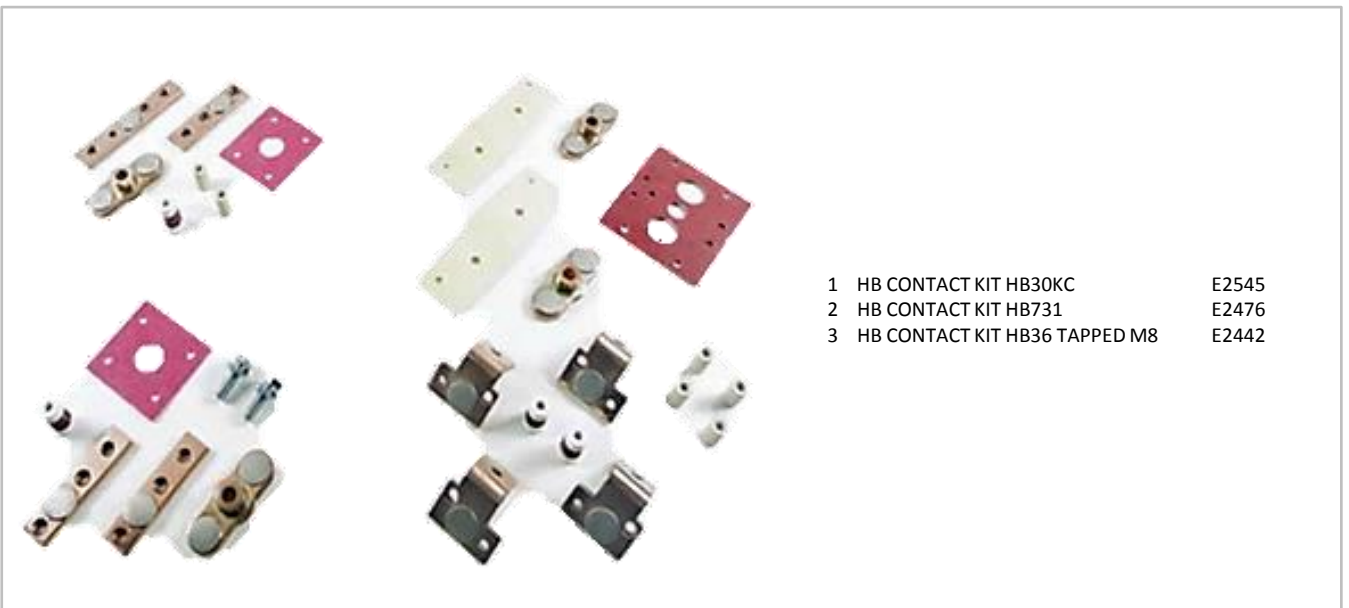

HB 200A Contact Kits





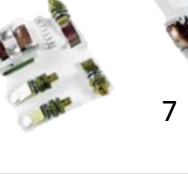

HB 300 A Contact Kits



Schaltbau Contactor Kits

					
				1 S165h CONTACT KIT 2 S165c CONTACT KIT 3 S164i CONTACT KIT 4 S164c CONTACT KIT 5 S137c CONTACT KIT 6 S137h CONTACT KIT 7 S163c CONTACT KIT 8 S163h CONTACT KIT	S3143/1 S3143/2 S2136 S2135 S3141/1 S3141/2 S3138 S3138/1

Schaltbau Components

			
			1 SWITCH ASSY S860.111 2 S126 110 KEY SWITCH ASSEMBLY 3 S187-Ax-7 CONTACT ASSY 4 S187-Ax-0 CONTACT ASSY
			S3267/01 S3268/01 S3146/2 S3146/1

Contact Kits and Components – Miscellaneous

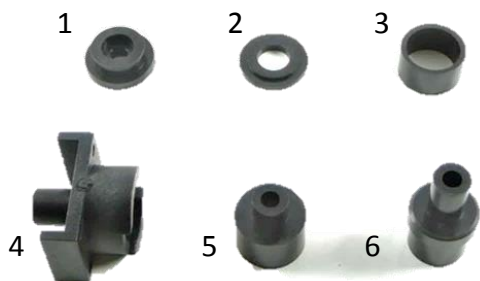

1	GE EV1 SPRING RETAINER	E2536/2
2	EV100 CONTACTOR TOP COVER	E2511/01
3	EV100 PLUNGER BUSHING	E2511/02
4	GE EV1 MOVABLE TIP CARRIER	E2449
5	EV100 UPPER BUS	E2511
6	EV100 MOVABLE TIP CARRIER	E2510

Bosch / Sevcon / Telemech / Hardellet Kits



1	SEVCON CONTACT KIT 300a CO	N1804
2	BOSCH CONTACT KIT FOR 0333200013	Z1020/01
3	SEVCON CONTACT KIT 300a NO	N1803
4	CONTACT KIT-TELEMECHANIQUE SPST	V2527
5	SEVCON CONTACT KIT 200a NO	N1801
6	CONTACT KIT-TELEMECHANIQUE DPST	V2528
7	SEVCON CONTACT KIT 200a CO	N1802
8	RDP20000 CONTACT KIT DP	L4586/K
9	DP20000 COVER DP	L4586/T
10	RC20000 CONTACT KIT SP	L4585/K
11	C20000 COVER SP	L4585/T

CAV Contacts



1	FIXED DET CONTACT	E2366
2	GE/CAV FIXED CONTACT 22mm DIA	E2301
3	GE/CAV FIXED CONTACT 16mm DIA	E2362

Micro switches 1

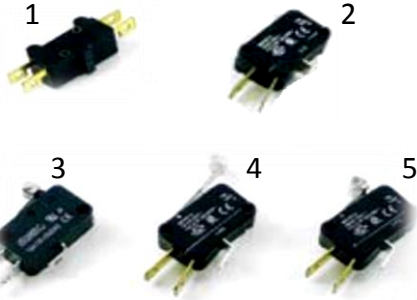

- | | |
|-------------------------------------|-------|
| 1. MICRO-SWITCH | V4951 |
| 2. MICRO SWITCH NOW WITH 6.3mm TABS | V4851 |
| 3. MICRO-SWITCH VCFJYR TYPE | V4942 |
| 4. MICRO-SWITCH VCFYR1 TYPE | V4852 |
| 5. MICRO-SWITCH VCFYR TYPE | V4860 |

This is just a small selection of switches we can offer. Please call us if you do not see what you need.



- | | |
|----------------------|----------|
| 1. MICRO-SWITCH V3S | V4925 |
| 2. MICRO-SWITCH V4NS | V4995/02 |



- | | |
|---------------------------------|-------|
| 1. MICRO-SWITCH DOUBLE 2V3Q2 UL | V4917 |
| 2. MICRO-SWITCH | V4802 |
| 3. MICRO-SWITCH CT2KR2-A2 TYPE | V4865 |

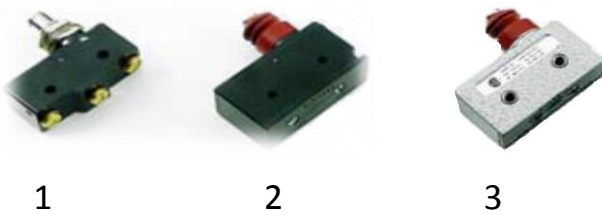

- | | |
|------------------------------|---------|
| 1. MICRO-SWITCH CT2Q-A2 TYPE | V4903 |
| 2. MICRO-SWITCH 3BR-103 | V4853/1 |
| 3. MICRO-SWITCH 4BR | V4853 |

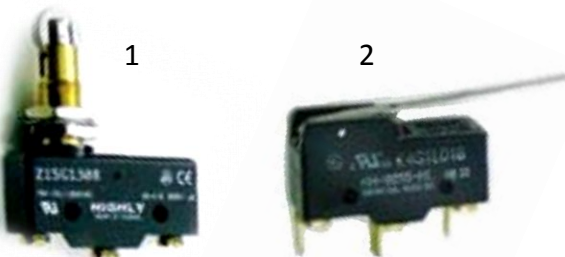

- | | |
|------------------------------------|---------|
| 1. MICRO-SWITCH CT2QR-1021-A2 TYPE | V4909/1 |
| 2. MICRO SWITCH | V4984 |

Snap Action Switches



S800 Series



Example: **S800 b 10/20/40 L**

Series / contact type	S800 1 NC, 1 NO, 1 contact bridge
Auxiliary actuator styles	<ul style="list-style-type: none"> a roller lever and mounting brackets as same as "a" with slotted holes b pushbutton (standard) c mounting brackets d "a" and angled mounting brackets e roller lever only
Contact material	<ul style="list-style-type: none"> none silver 10 gold
Terminals	<ul style="list-style-type: none"> none screw with saddle clamp 20 flat quick-connect 6.3 mm x 0.8 mm
Actuating and release forces	<ul style="list-style-type: none"> none standard: 3.3 N max. / 0.2 N min. 40 stronger spring: 5.5 N max. / 2.9 N min
Special design, optional	<ul style="list-style-type: none"> L Blowout magnets



S926 Series

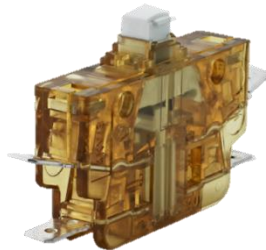

S926 series

- ▶ Better temperature resistance: -55°C ... +105°C, dependent on variant
- ▶ Better resistance to chemical influences
- ▶ Better impact resistance (PEI 50% more resistant than PC)
- ▶ SPDT-DB (Form Zb) with double-break contacts
- ▶ Snap-action switch with 4 terminals
- ▶ Positive opening operation
- ▶ Wiping action
- ▶ 2 galvanically isolated contact bridges



S880 Series



Applications

- ▶ Safety limit switch in medical engineering
- ▶ Limit switch for machine and system control, product engineering, elevator technology and material handling
- ▶ Safety limit switch in access locking systems, door and barrier control
- ▶ Control switch in heating, ventilating, and air-conditioning systems
- ▶ Switches for driver's cab of rail vehicles, control panels in cranes and on the bridges of ships.

Key Switches



Lever Switches



Carbon Brushes

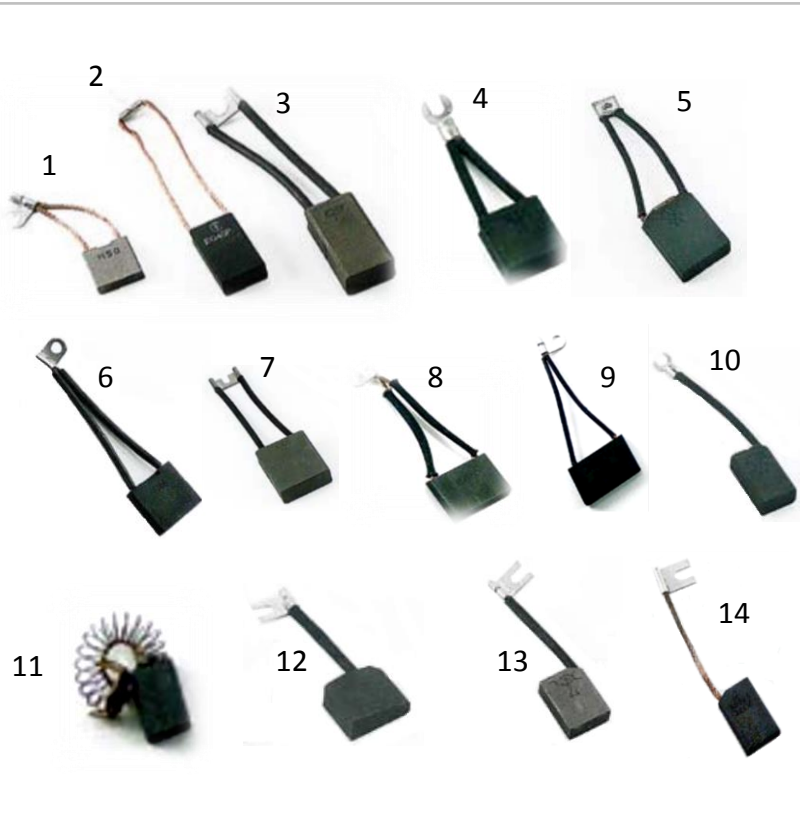

		Width	Thickness	Length
1	B4333	28	15.5	30
2	B4041	30	15	25
3	B4329	30	15	26
4	B4151	31.8	12.7	32
5	B4264	32	12.5	45
6	B4110	32	9.5	27
7	B4355	40	16	45
8	B4350	40	10	31
9	B4104	38	9.5	27
10	B4348	20	12.5	32
11	B4354	9.5	6	15
12	B4337	35	17-09	30-27
13	B4411	25	12	33
14	B4255	22	12.5	35

This is a small selection of the available range. Contact us if you do not see what you want.

Comm Sticks

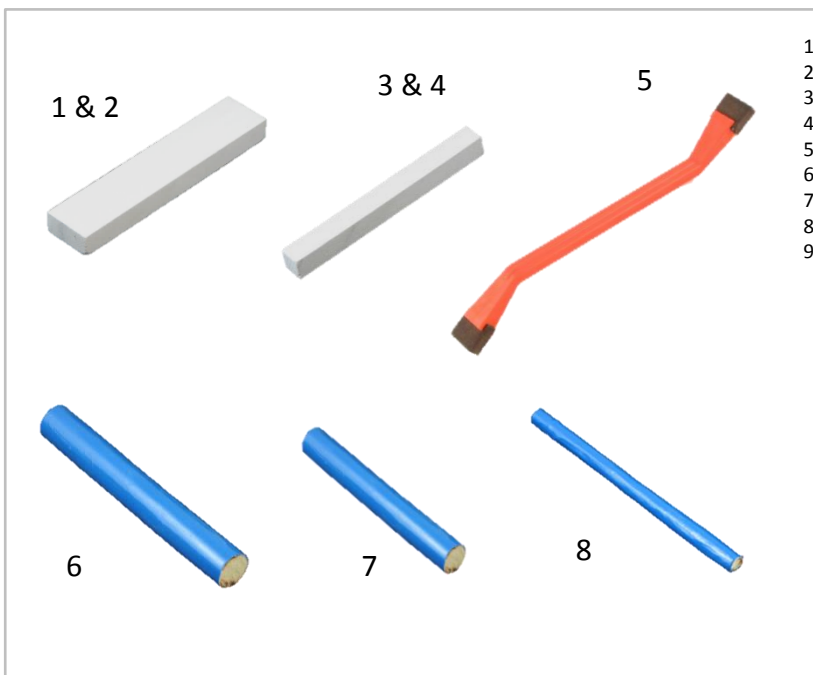

1	COMM STONE 25x12x120 MEDIUM	B4404
2	COMM STONE 25x12x120 HARD	B4405
3	COMM STONE 16x12x120 MEDIUM	B4406
4	COMM STONE 12x12x120 MEDIUM	B4407
5	COMMUTATOR SMOOTHIE	B4408
6	COMM STICK 25.4MM DIA	B4400
7	COMM STICK 19MM DIA	B4401
8	COMM STICK 6.5MM DIA	B4403/01
9	WHITE PUMICE STICK (4 PER PACK)	ES14-35

Fuses

For Different fuse ratings, please call us

1	BUSS FUSE ACK 150A	G5304/150
2	BUSS FUSE ACK 30A	G5304/30
3	BUSS FUSE ANL 250a	G5306/250
4	MEGA FUSE 250 AMP	G5509/250
5	CERAMIC FUSE FAST 20mm x 5mm 3.15A	G5500/315
6	CERAMIC FUSE 1.25 x 0.25in 10A	G5502/10
7	OPEN FUSE 50a 30mm	G5102/50
8	ENCLOSED FUSE 50a 30mm	G5002/50
9	BUSS FUSE (FNM) 40A	G5302/40
10	ENCLOSED FUSE 175A	G5001/175
11	OPEN FUSE 225a	G5101/225

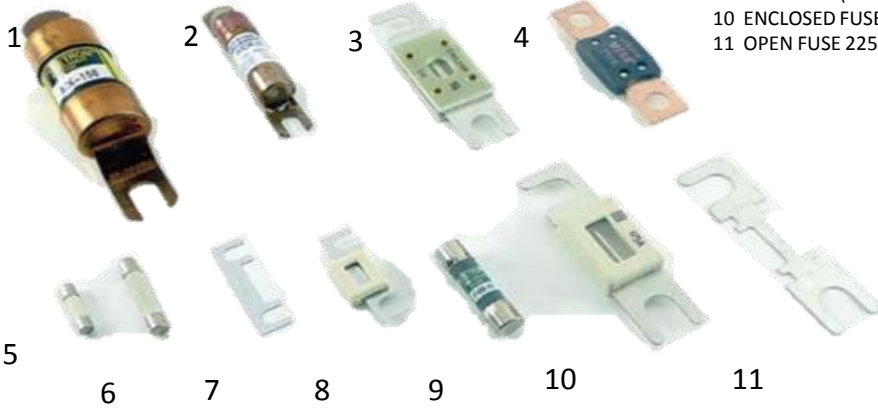

For Different fuse ratings, please call us

1	HRC FUSE 500A	G5150/500
2	HRC FUSE 355A	G5150/350
3	HRC FUSE 25A	G5160/25
4	BUSS FUSE KAA 400a	G5190/400
5	HRC FUSE 20A - 20LCT	G5160/20



Fuse Holder

Options Available -

1-1691-178421	SH-1P	1 Pole
1-1691-178443	SH-2P	2 Pole
1-1691-178454	SH-3P	3 Pole

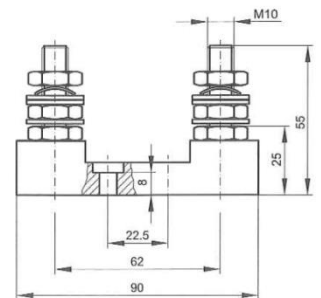

Hour Meters, Lamps, Beacons & Buzzers



1 BDI+HM+LL+DS 24-72v Z1200/114



2 HOUR METER 10/80v CIRCULAR V6010/02



1



2



3

- 1 STROBE LIGHT 12-80v ML2 V7065/01
- 2 HORN 24v (Various Voltages Available) M6969/24
- 3 BACK-UP ALARM 12-80v V7021/01



1



2



3

- 1 STEER WHEEL SPINNER - PHENOLIC L9007/01
- 2 STEER WHEEL SPINNER - METALLIC L9007
- 3 PROGRAMMABLE SECURITY LOCK Z35-PSL/02

Additional products and information are available
From our web page - www.Schaltbau-me.com

Electrical components and systems for railway
engineering and industrial applications

Connectors

- Connectors manufactured to industry standards
- Connectors to suit the special requirements of communications engineering (MIL connectors)
- Charging connectors for battery powered machines and systems
- Connectors for railway engineering, including UIC connectors
- Special connectors to suit customers requirements

Snap-action switches

- Snap-action switches with positive opening operation
- Snap-action switches with self-cleaning contacts
- Enabling switches
- Special switches to suit customer requirements

Contactors

- Single and multi-pole DC contactors
- High voltage AC/DC contactors
- Contactors for battery powered vehicles and power supplies
- Contactors for railway applications
- Terminal bolt and fuse holders
- DC emergency stop switches
- Special contactors to suit customer requirements

Electrics for rolling stock

- Equipment for driver's cab
- Equipment for passenger use
- High Voltage switchgear
- High Voltage heater
- High Voltage Roof equipment
- Equipment for electric brakes
- Design and engineering of train electrics to customer requirements

Schaltbau Machine Electrics Ltd
Has been certified to ISO9001
for more than 10 years and is
certified to ISO14001

Schaltbau Machine Electrics Ltd
Manufactures in compliance
with RoHS



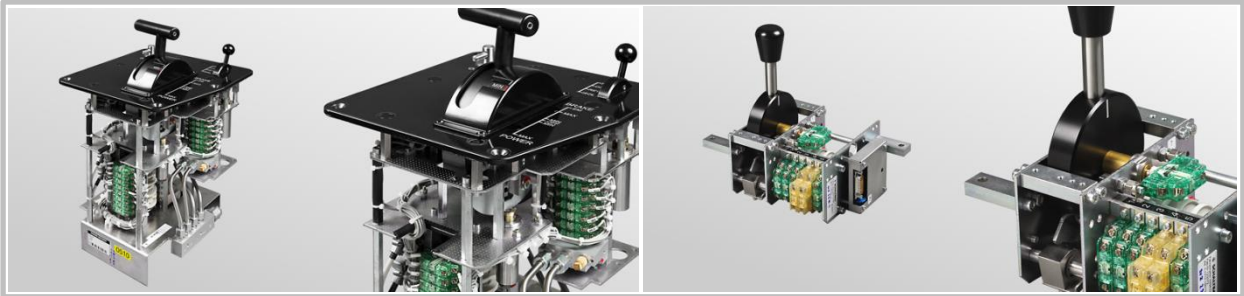
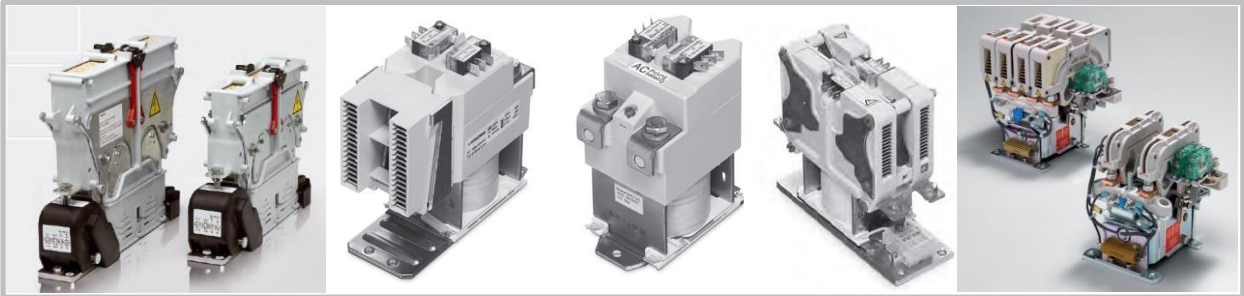
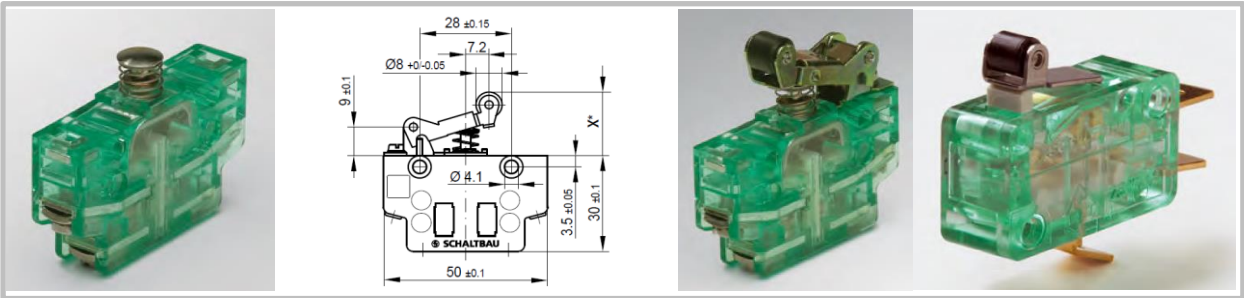

Schaltbau Machine Electrics Ltd

Units 335-336
Springvale Industrial Estate Woodside Way
Cwmbran
NP44 5BR
United Kingdom

T: +44 (0) 1633 877 555 f: +44 (0) 1633 873 366

E: sales@schaltbau-me.com w: www.schaltbau-me.com